

SEIKO

QUARTZ *LC*

Cal. 0674A

PARTS LIST

Calibre No. <h1 style="text-align: center;">0674A</h1>	Jewels <h1 style="text-align: center;">0j</h1>	Style Name <h1 style="text-align: center;">QUARTZ LC</h1>
--	--	---

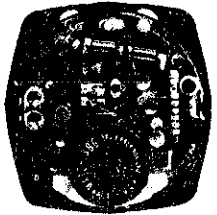
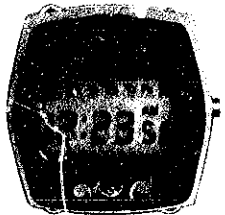

Characteristics

Casing diameter : 27.0 ϕ mm
 Maximum height : 8.5 mm
 Frequency of quartz crystal oscillator : 32,768 Hz
 (Hz=Hertz Cycle per second)
 Time functions : Digital Display System showing hour, AM, PM, minute, second & day of the week
 Calendar functions : Digital Display System showing year, month, date & day of the week
 Display medium : Single Crystal Display (Nematic Liquid Crystal, FE-mode)
 Time micro-adjustor : Trimmer condenser system
 Illumination light for digital display panel :
 Illuminated in coordination with the touch-button depressing



383 649



782 643



4001 656



4032 643



4245 649



4398 649

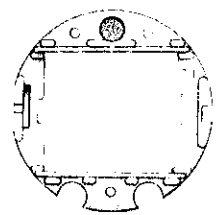

4408 652

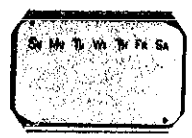

4501 690



4521 680

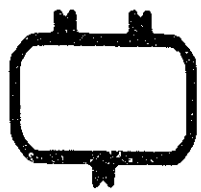

4540 644



022 452



U.C.C. 386

Calibre No. 0674A	Jewels 0j	Style Name QUARTZ LC
-----------------------------	---------------------	--------------------------------

PART NO.	PART NAME	PART NO.	PART NAME
383 649	Setting lever		
782 643	Setting lever spring		
4001 656	Circuit block		
4032 643	Bulb (with terminal)		
4245 649	Setting switch spring		
4398 649	Battery guard		
4408 652	Frame for liquid crystal panel		
4501 690	Liquid crystal panel		
4521 680	Reflecting mirror		
4540 644	Spring for liquid crystal panel		
022 452	Bulb holding screw		
U.C.C. 386	Silver oxide battery		

TECHNICAL GUIDE

SEIKO

DIGITAL QUARTZ

CAL.0674A

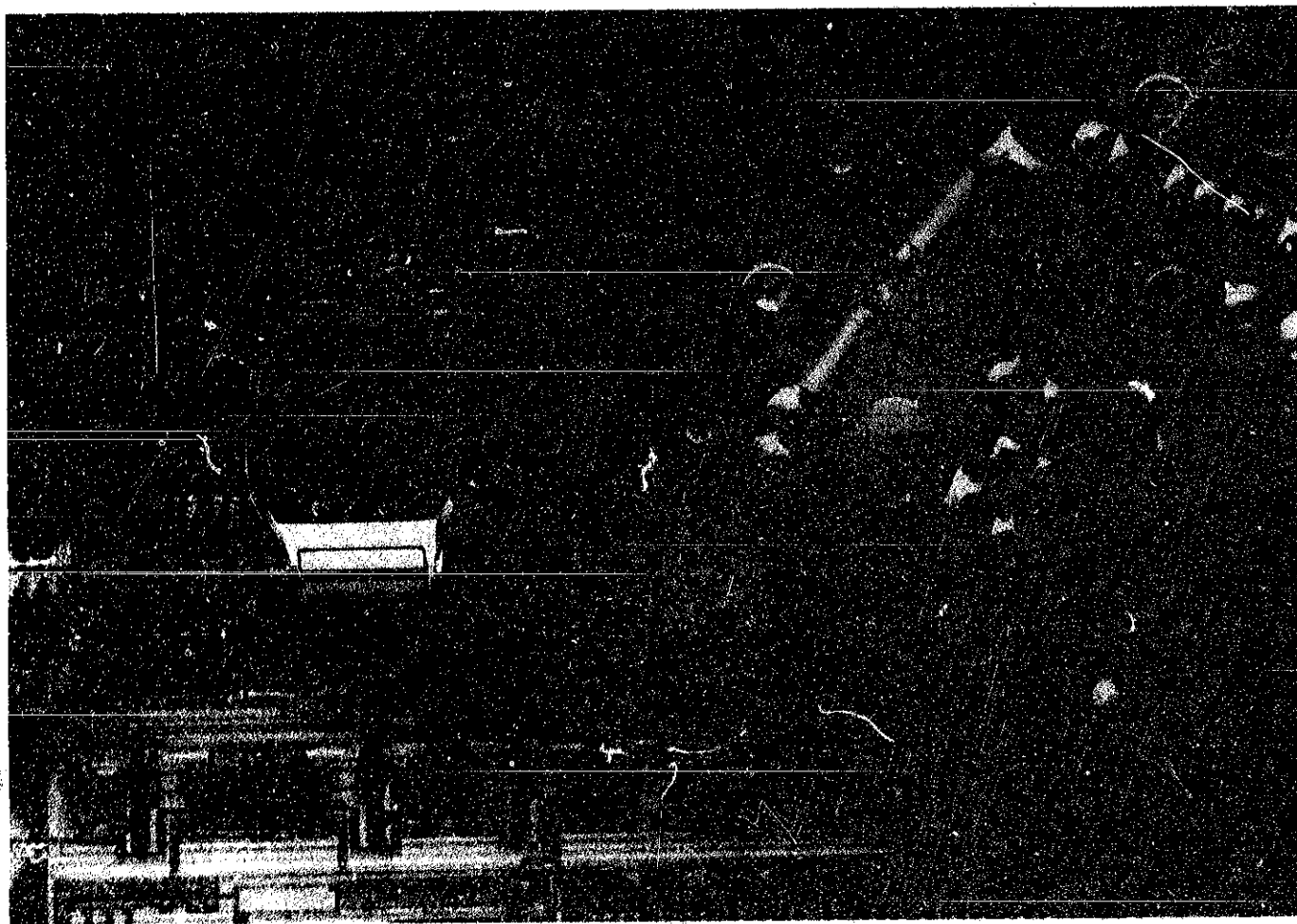

CONTENTS

I. SPECIFICATIONS AND FEATURES	1
1. Specifications	1
2. Features	1
II. HOW TO SET THE TIME AND CALENDAR	2
1. How to set the time	2
2. How to set the calendar	3
III. DISASSEMBLING AND REASSEMBLING	4
1. After-sale servicing instruments and materials	4
2. Disassembling and reassembling of the case	5
3. Disassembling and reassembling of the movement and lubricating of the switch components	6
4. Cleaning	7
IV. CHECKING AND ADJUSTMENT	9
1. Guide table for checking and adjustment	9
2. Malfunction and checking points	10
3. Segment and MOS-IC output terminal	11
4. Practical checking and adjustment	12
A. Check battery voltage	12
B. Check contact of MOS-IC and liquid crystal panel	12
C. Check liquid crystal panel and circuit block	13
D. Check current consumption	13
E. Check accuracy	13
F. Time accuracy adjusting	14
G. Check time and calendar conditions	15
H. Check switch components	15
I. Check bulb condition	16

Calibre 0674A

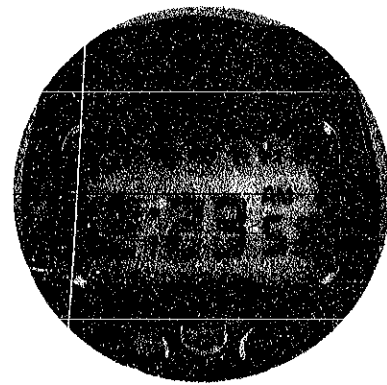

Time Function

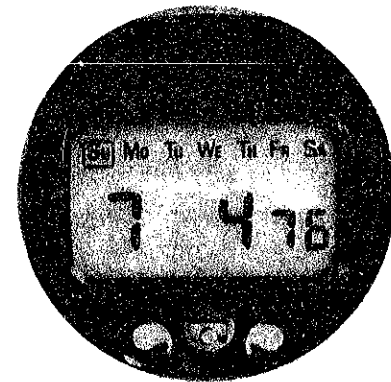

Calendar Function

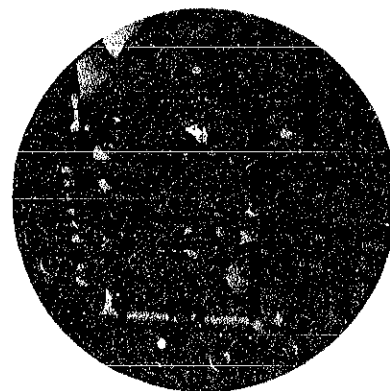

Movement

I. SPECIFICATIONS AND FEATURES

1. Specifications

Item	Calibre No.	0674A
Display system		Two function changeover system <ul style="list-style-type: none"> • Time functions: Digital Display System showing hour, AM, PM, minute, second & day of the week. • Calendar functions: Digital Display System showing year, month, date & day of the week.
Display medium		Single Crystal Display (Nematic Liquid Crystal, FEM (field effect mode))
Operation		Push time adjusting button on the front panel: <ul style="list-style-type: none"> • Time function/Calendar function changeover mechanism • Instant adjusting device of year, month, date, day of the week, hour (AM, PM), minute and second by selection and setting system (can be adjusted separately). • Instant second resetting to "00" device • Illuminating light.
Crystal oscillator		32,768 Hz. (Hz. = Hertz . . . cycle per second)
Loss/gain		Loss/gain at normal temperature range Mean monthly rate: less than 10 seconds (Annual rate: less than 2 minutes)
Casing diameter		φ 27.00 mm
Height		8.5 mm
Operational temperature range		-10°C ~ +60°C (14°F ~ 140°F)
Regulation system		Trimmer condenser
Battery power		Silver oxide battery (U.C.C. 386) Battery life is over one year.
IC (Integrated circuit)		C-MOS-LSI 1 piece Hybrid-IC 1 piece

2. Features

- (1) It is a calendar watch to display year (Christian Era), month, date, day of the week, hour, AM, PM, minute and second, and it automatically adjusts the even and odd months and also the leap year change (up to 2009).
- (2) Two-function changeover system
The calendar function and time function can be selected by pushing the changeover button.
- (3) Cal. 0674A has all of the excellent qualities of the basic function of the 06 Series.

II. HOW TO SET THE TIME AND CALENDAR

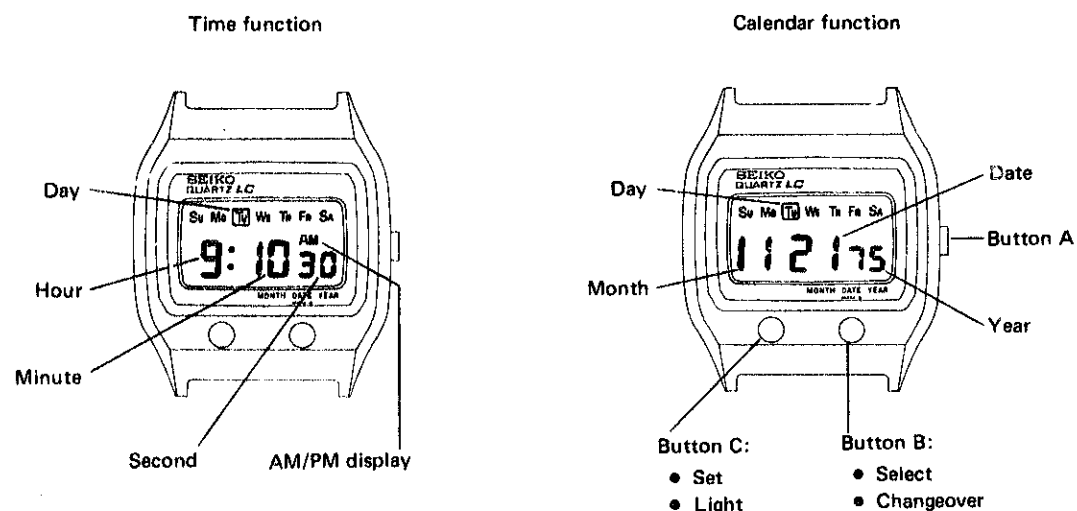

How to change function

A newly developed two-way changeover system has made it possible to indicate either the time display or the calendar display by simply depressing button "B" with button "A" (lock switch) in a normal position. The time display and calendar display can be used independently and the functions of each can be used or adjusted without disturbing the continuous operation of the other.

1. How to set the time

The setting is made in the order of the second, minute, hour & day. First, be sure that the display is indicating the time function.

- Button "A" (lock switch) must be released in order to adjust the time. Otherwise, setting the time is impossible.
- Button "B" will serve as the "select" button for selecting the digits to be changed and button "C" will serve as the "set" button which changes the digits.

(1) To set the second digits

Pull out button "A". The second digits will start blinking. This indicates that the second digits are ready to be adjusted. Depress button "C" in accordance with the "00" second of a time signal and the seconds are then reset to "00" and start immediately.

Note:

When the seconds count any numbers from "00" to "29" the seconds are reset to "00" automatically whenever button "C" is depressed. When the seconds count "30" to "59" and button "C" is depressed, one minute is added and the seconds immediately return to "00".

(2) To set the minute digits

With button "A" still in the pulled out position and the second digits still blinking, depress button "B" and the minute digits will start blinking. This indicates that the minute digits are ready to be adjusted. Now, one minute is advanced by each depression of button "C". The minute digits are adjusted independently from the hour digits. During adjustment, the hour digits do not advance, although the minute digits may pass the "59" minutes.

(3) To set the hour digits

With button "A" still in the pulled out position and the minute digits still blinking depress button "B" again. The hour digits will start blinking. One hour is advanced by each depression of button "C". The hour digits are adjusted independently from the day and date digits. During adjustment, the day and date digits do not advance although the hour digits may pass 12 midnight.

While setting the hours be sure to set AM or PM indication. This will insure the calendar changing at midnight.

(4) To set the day of the week

With button "A" still in the pulled out position and the hour digits still blinking, depress button "B" again. The indicating square frame of the day will start blinking. Now, the frame can be moved to the next day by each depression of button "C". The day setting is made independently from the date.

When the time setting completed, be sure to push button "A" in.

Time function

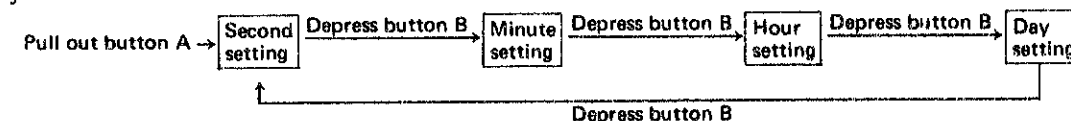

2. How to set the calendar

The setting is made in the order of the year, date, month and day of the week. First, be sure that the display is indicating the calendar function.

- Button "A" (lock switch) must be released in order to adjust the calendar. Otherwise, setting the calendar is impossible.
- Button "B" will serve as the "select" button, for selecting the digits to be adjusted, and button "C" will serve as the "set" button, which changes the digits.

(1) To set the year

Pull out button "A". The year digits will start blinking. This indicates that the year digits are ready to be adjusted. The year digits can be advanced one digit by each depression of button "C". Once it is set, the calendar will change automatically year after year, even in a leap year. The year digits can cover from 1976 to 2009.

(2) To set the date

With button "A" still in the pulled out position and the year digits still blinking, depress button "B", and the date digits will start blinking. Now, one date is advanced by each depression of button "C". The date digits are adjusted independently from the month digits. During adjustment, the month digits do not advance although the date digits may pass the last date of the month.

(3) To set the month

With button "A" still in the pulled out position and the date digits still blinking, depress button "B", and the month digits will start blinking. Now, one month is advanced by each depression.

Calendar function

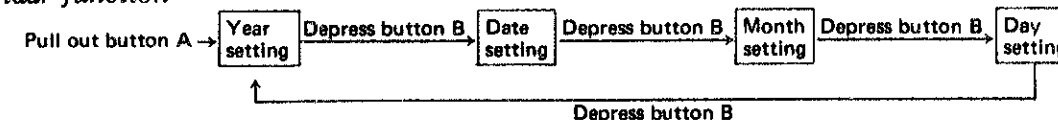

How to use the light

Button "C" serves both for setting the time and calendar. It also activates the illuminating light. Push button "C" when button "A" is in the normal position. This will activate the light which illuminates the digits.

This watch is designed so that the battery will last at least one year even if the light button is used ten times each day for one second at a time.

If use of the light button is more frequent than ten times daily, the battery life may be shortened to less than one year.

Remarks for battery replacement

After battery replacement, if two or three days of the week are framed, this is not a malfunction. The display must be corrected by following the day setting procedures and keep cycling the frame until the correct day is properly framed. (Refer to "To set the day of the week" on this page.)

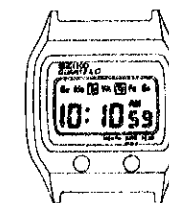

III. DISASSEMBLING AND REASSEMBLING

1. After-sale servicing instruments and materials

For after-sale servicing of SEIKO Quartz Digital Cal. 0674A, the following after-sale servicing instruments and materials are necessary.

(1) Quartz Tester

Used to check time accuracy (daily rate) of both QT-10 and QT-100. The microphone is different, however.

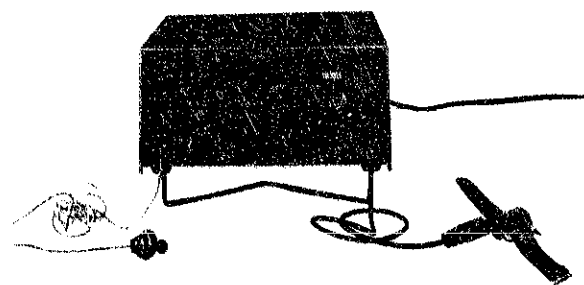

• Electric-field detection microphone for QT-10

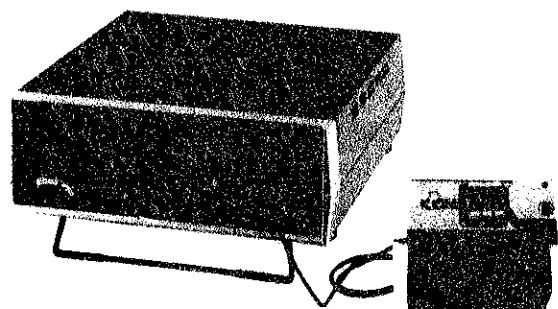

• Oscillation detection microphone for QT-100

(2) Volt-ohm-meter

Used to check battery voltage and measure current consumption.

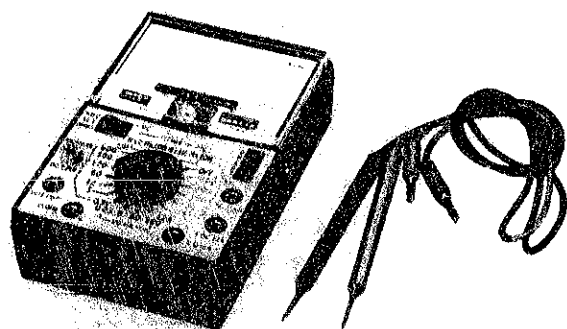

(3) Movement holder

Used for disassembling and reassembling of the movement.

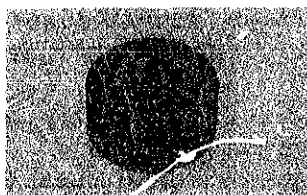

(4) Battery holding spring

Used for securing battery and flowing current when the movement is removed from the case.



2. Disassembling and reassembling of the case

Disassembling procedures Figs.: ① ~ ⑩

Reassembling procedures Figs.: ⑩ ~ ①

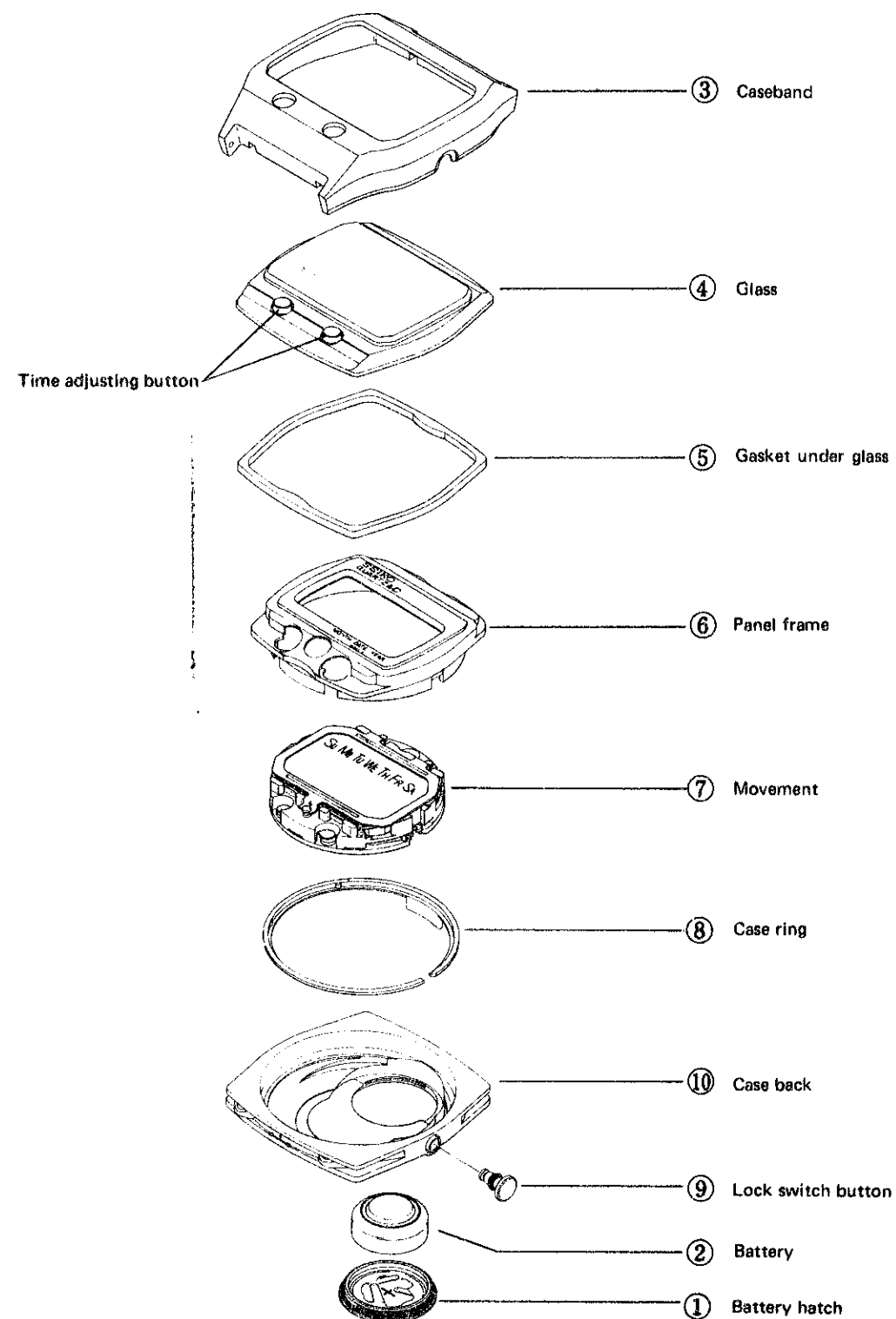

3. Disassembling and reassembling of the movement and lubricating of the switch components

Disassembling procedures Figs.: ① ~ ⑪

Reassembling procedures Figs.: ⑪ ~ ①



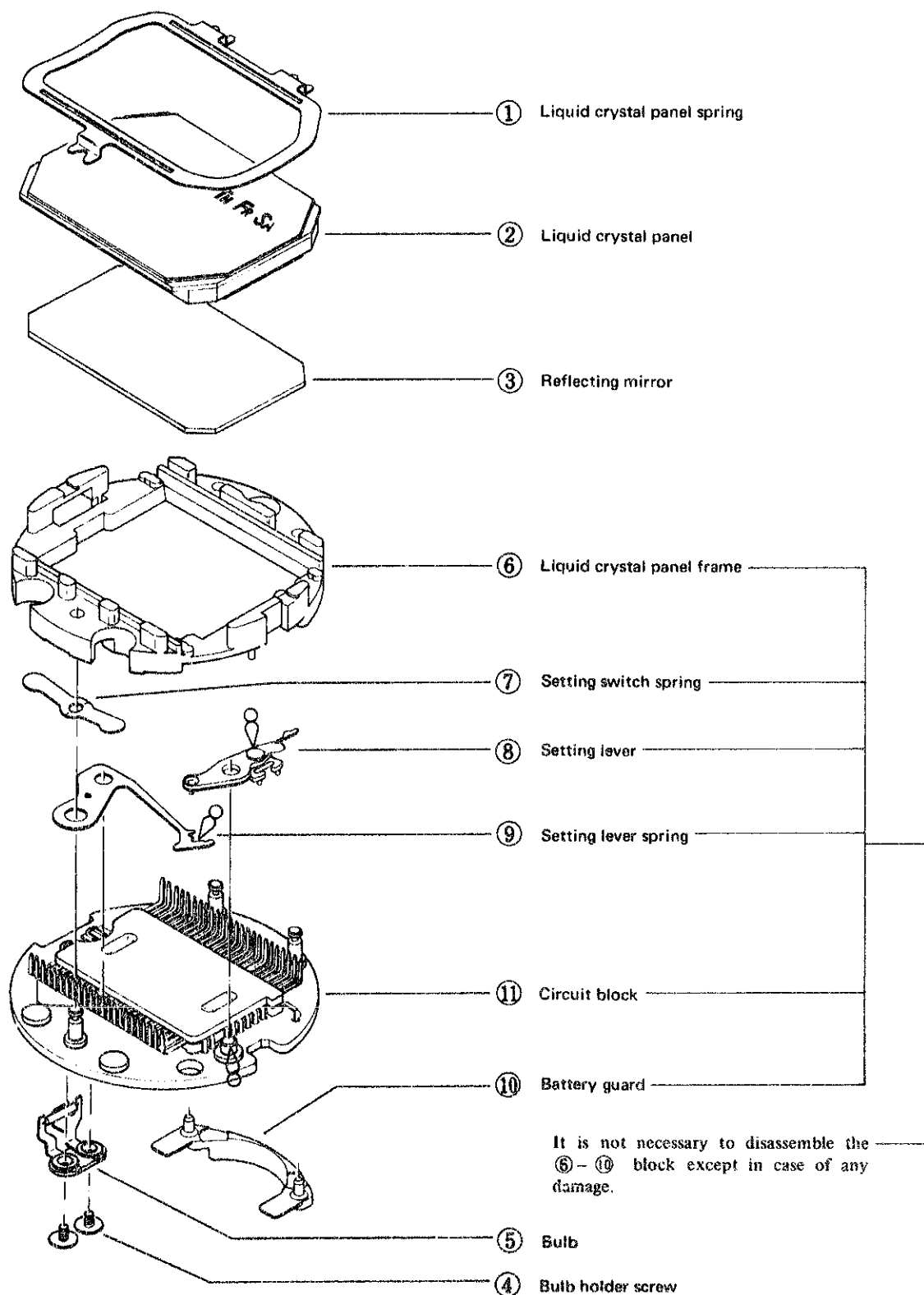





Lubricating ∞ : SEIKO Watch Oil S-6, normal quantity

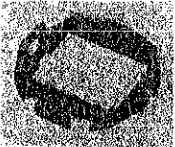

4. Cleaning

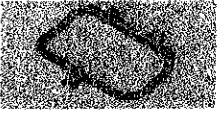
Since several parts of 0674A differ from conventional mechanical watches, use the following method when cleaning.

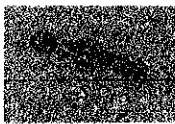
HOW TO CLEAN

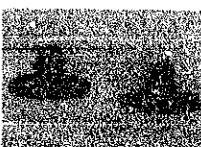
Name of part	Cleaning	Drying	Solution	Remarks
(1) Liquid crystal panel 	DO NOT CLEAN			Wipe the electrode with a cloth moistened with benzine. The other parts should be cleaned with a soft dry brush only.
(2) Circuit block 	DO NOT CLEAN			Wipe dust and lint off the MOS-IC contacts with a soft dry brush. For other contacts, use a cloth moistened with benzine.
(3) Reflecting mirror 	DO NOT CLEAN			Wipe the reflecting mirror with a soft brush or cloth moistened with alcohol if contaminated. Be careful not to scratch.
(4) Plastic parts Liquid crystal panel frame Battery guard  	Wash with a soft dry brush	Cool air	Alcohol Benzine	
(5) Bulb 	Rinse	Cool air	Alcohol Benzine	Don't use the ultrasonic cleaning
(6) Parts other than above Liquid crystal panel spring Setting lever spring Setting switch spring Setting lever Bulb holder screw     	Wash with a soft dry brush	Cool or hot air drying	Benzine, trichloro-ethylene	When cleaning the setting lever, be careful not to damage the thin spring.

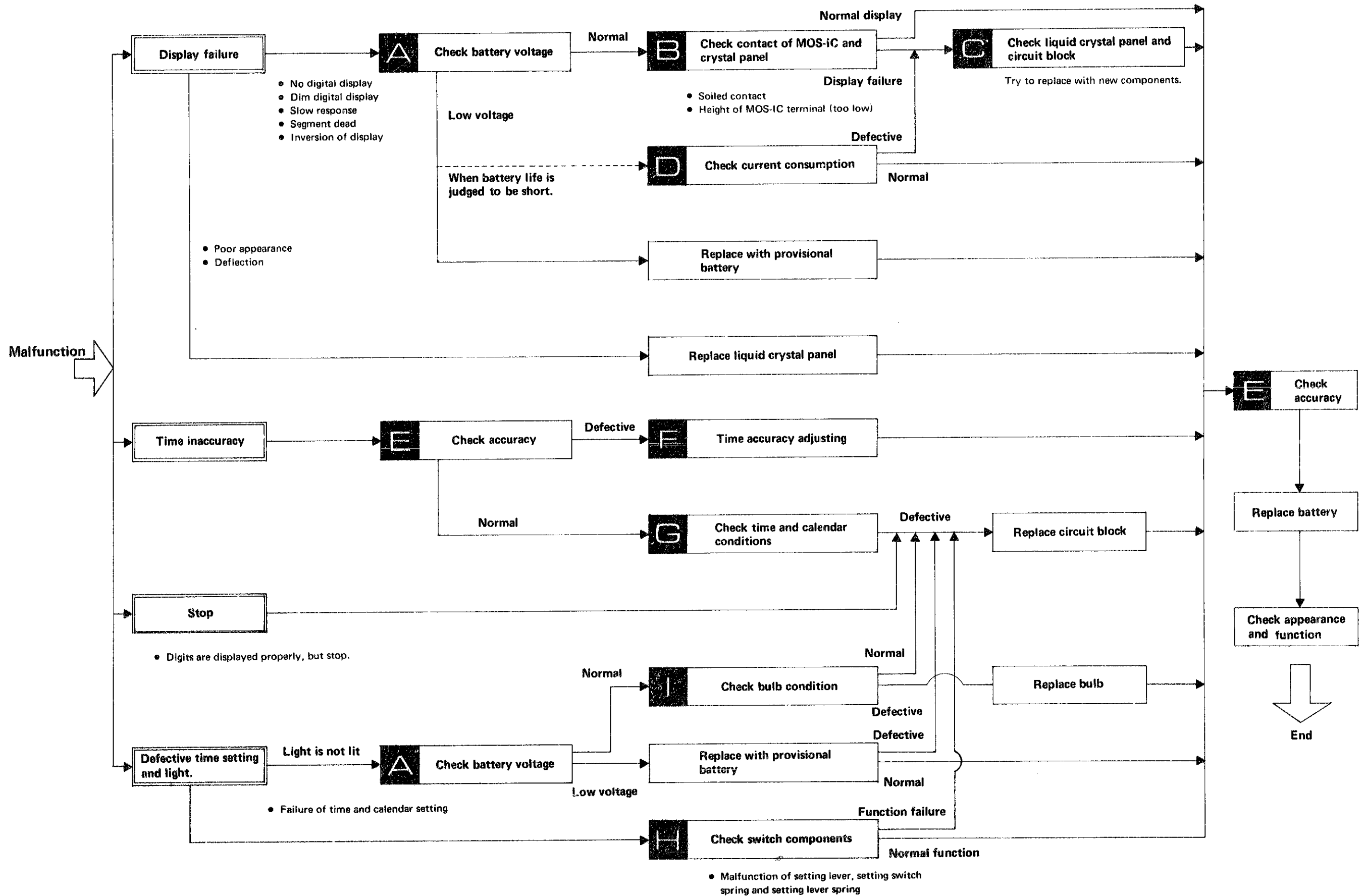

IV. CHECKING AND ADJUSTMENT

1. Guide table for checking and adjustment

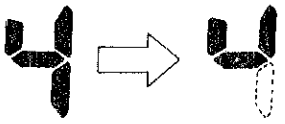
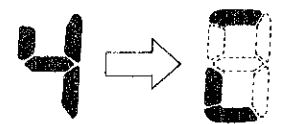

2. Malfunction and checking points

- Check in the numerical order.
- Refer to "Guide table for checking and adjustment" on page 9.

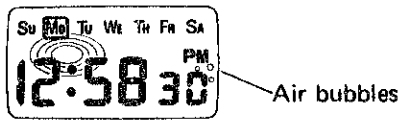
FAULTY SYMPTOMS		CHECKING POINTS							
		A	B	C		F	G	H	I
		Battery voltage	Contact of MOS-IC and liquid crystal panel	Liquid crystal panel	Circuit block	Time accuracy adjusting	Check time and calendar conditions	Switch components	Bulb
Display failure	No digital display, dim digital display or extremely slow response	①		②	③				
	(Segment dead) One or a few segments are not lighted or dim. Example: 		①	②	③				
	(Inversion of display) The segments which are to be lighted are turned off, or the segments which should not be lighted are turned on. Or all segments are turned on. Example: 		①	②	③				
	(Deflection) Some or all of one segment show different contrast depending on the direction of view. Example:  (Poor appearance) Some portions of the liquid crystal panel will make air bubbles or iridescent view. Example: 			①					
Time inaccuracy	Gain or loss tested by Quartz tester.					①			
	Though Quartz tester indicates the normal figures, a watch gains or loses when it is worn on the wrist.				②		①		
Defective time and calendar setting or light	Light is not lit or light is lit but dims soon.	①			④			③	②
	Failure of time and calendar setting.				②			①	
Stop (Digits are displayed properly, but stop.)					①				

3. Segment (Electrode of Liquid Crystal Panel) and MOS-IC output terminal

(1) Segment

• Segment



• Identification of digits

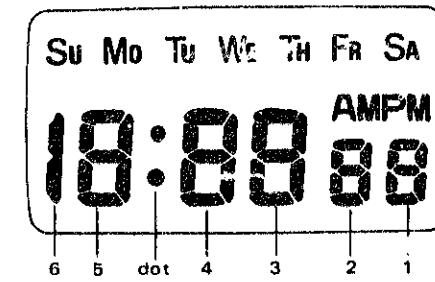

Example: The segment in mark ○ is called "4d".

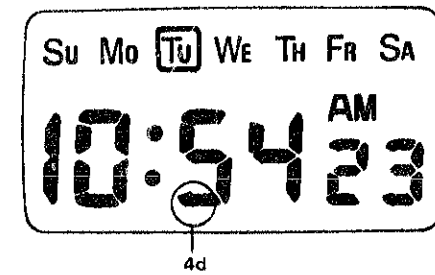

(2) Connection with MOS-IC output terminal

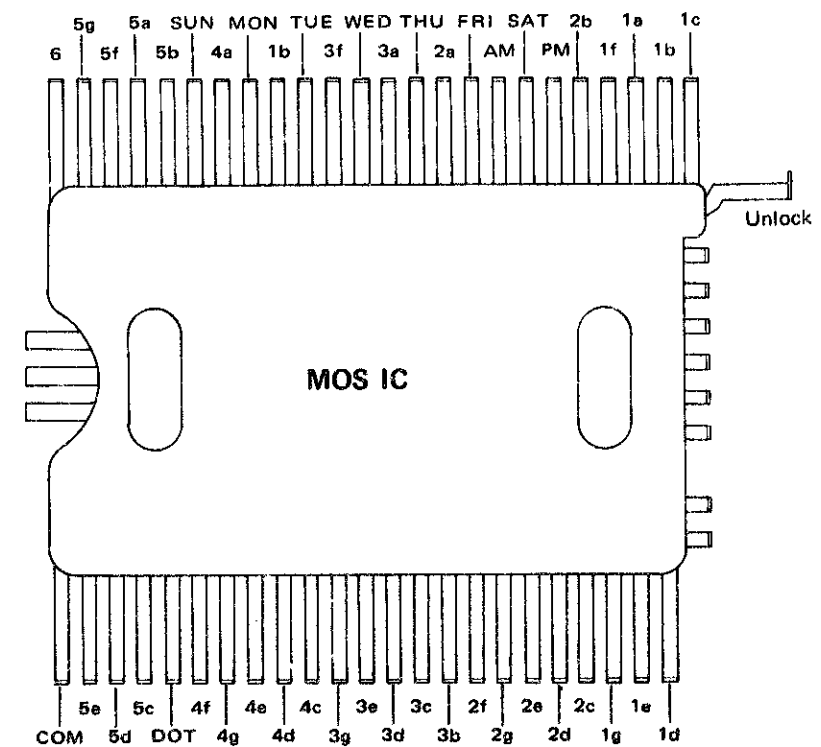

4. Practical checking and adjustment

A Check battery voltage

Use the following procedures to check battery voltage.

- (1) Set up the Volt-ohm-meter
Range to be used: DC 3 V

(2) Measuring

- Probe Red (+) Battery surface (+)
- Probe Black (-) Battery surface (-)

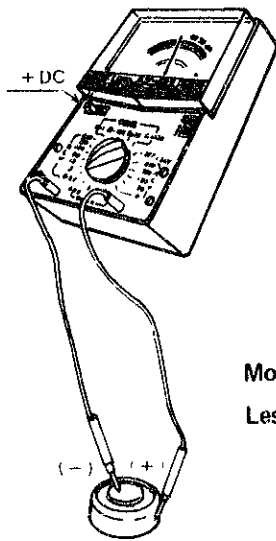

More than 1.5 V . . . Normal
Less than 1.5 V . . . Defective

B Check contact of MOS-IC and liquid crystal panel

Set up the battery with the battery holding spring before checking.

Remarks: Do make sure to check the terms of (1) and (2) in "Remarks for battery replacement" on page 3.

After removing the liquid crystal panel, check the conductivity of the electrode of the liquid crystal panel and MOS-IC output terminals.
(See page 11 for "Segment and MOS-IC output terminal".)

- (1) Check to see if there is any contamination on the liquid crystal panel electrodes and the MOS-IC output terminal.

No foreign matter . . . Normal
Foreign matter . . . Defective
Wipe off any foreign matter.

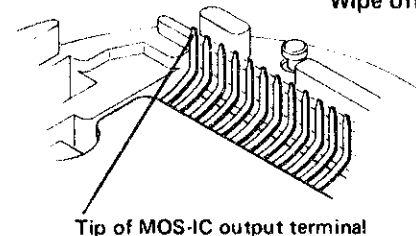
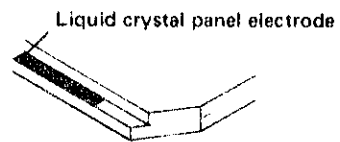

- (2) Check contact conditions by examining the height of the MOS-IC output terminals to see if they are too low.

Raise, with tweezers, the tips of the MOS-IC output terminal to connect the liquid crystal panel electrodes of these segments until the segments light up.

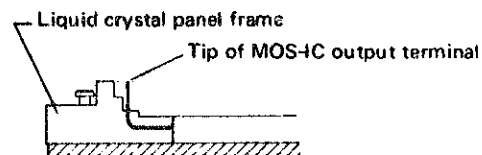

- After assembling the liquid crystal panel, check to see if the segments light up.

Light up Normal
Does not light up . . . Defective
. Proceed to



C Check liquid crystal panel and circuit block

After replacing the liquid crystal panel or the circuit block, check to see if the watch works correctly.

D Check current consumption

Check to see if the current consumption is normal in the following conditions.

- Time function
 - (1) Lock switch button at the normal position
 - (2) Lock switch in the pulled out position
- Calendar function
 - (1) Lock switch button at the normal position
 - (2) Lock switch in the pulled out position
- Volt-ohm-meter
Range to be used: DC 0.03 mA

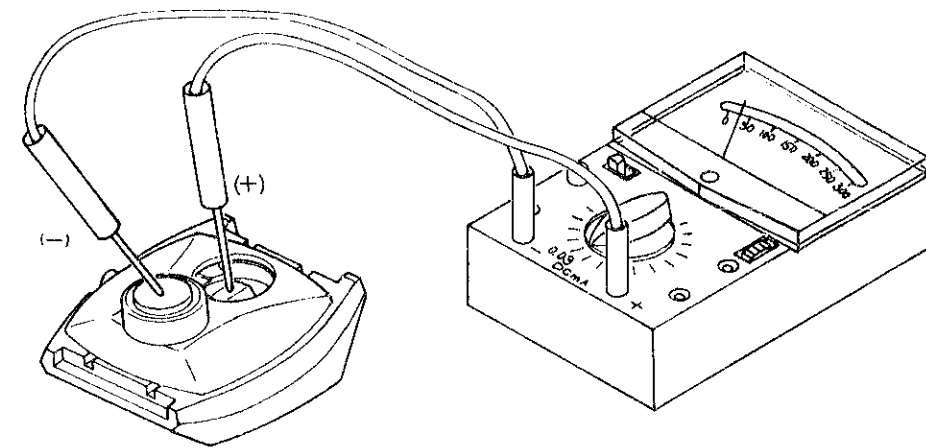

Probe Red (+) Battery lead terminal (+)
Probe Black (-) Battery surface (-)

Less than 6 μ A . . . Normal
More than 6 μ A . . . Defective

E Check accuracy

- Use the electric-field detection microphone for QT-10.
(See "How to use Quartz Tester QT-10" of the Technical Guide for Cal. 0624A, page 6.)
- Use oscillation detection microphone for QT-100.

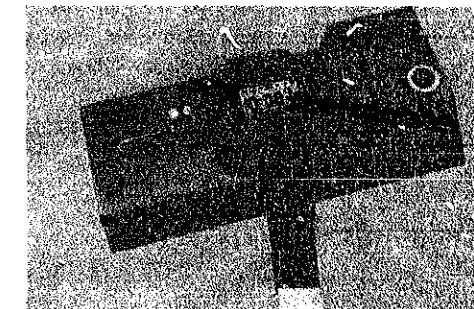

F Time accuracy adjusting

Time accuracy of Cal. 0674A is adjusted by turning the trimmer condenser.

Adjusting method

The watch will gain or lose according to the direction in which the trimmer condenser is turned. Adjustment should therefore be made after ascertaining with the Quartz Tester whether the watch tends to gain or lose.



Note for handling the trimmer condenser

Avoid excessive depressing and turning of the trimmer condenser.

Function of the Trimmer Condenser

The trimmer condenser consists of a rotor electrode and a stator electrode as shown in the diagram. Turning the shaft fixed to the rotor changes the overlapped area between the stator electrode and rotor electrode, which in turn changes the capacity of the trimmer condenser.

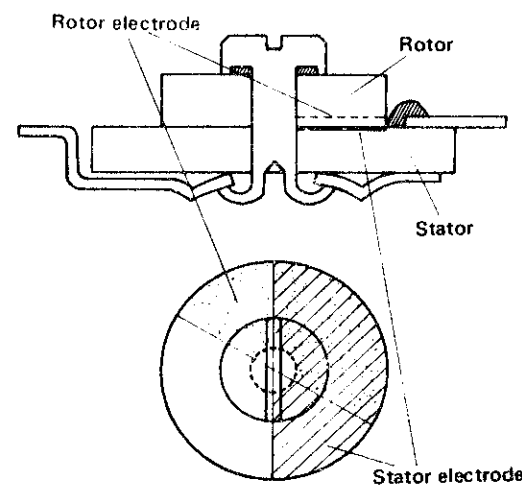

Change in the capacity of trimmer condenser and the adjusting accuracy rate.

Turning the trimmer condenser changes its capacity as shown in the diagram.

The trimmer condenser has been so adjusted at the factory so as to let the watch gain when it is turned clockwise and vice versa. Whenever adjustment is needed, however, turn the trimmer condenser while examining the gain and loss by the Quartz Tester.

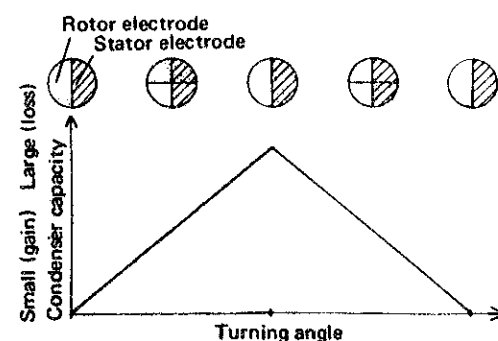

G Check time and calendar conditions

Time function

- (1) Check if the second digit appears exactly from "00" to "59", and one minute is added after 60 seconds.
- (2) Check the following conditions:
 - Minute setting condition: More than 60 minutes.
 - Hour setting condition: More than 12 hours.
 - Day setting condition: More than one week.

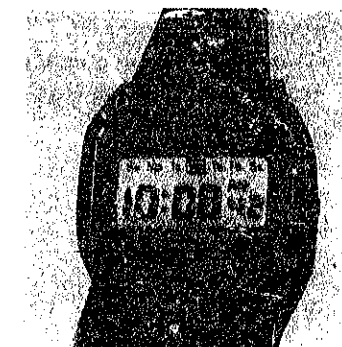

Calendar function

Check the following conditions:

- Year setting condition: 19"76" ~ 20"09"
- Date setting condition: More than 31 days
- Month setting condition: More than 12 months

H Check switch components

Check to see if the lock switch button and the time adjusting buttons work correctly.

(1) Check to see if the lock switch button functions correctly.

- Check to see that the thin spring of the setting lever touches the unlock terminal when the lock switch button is pulled out, and that the thin spring of the setting lever is set apart from the unlock terminal when the lock switch button is pushed in.

Remarks:

- Make sure that there is no foreign matter (dust, lint, etc.) on the thin spring of the setting lever and unlock terminal contacts.

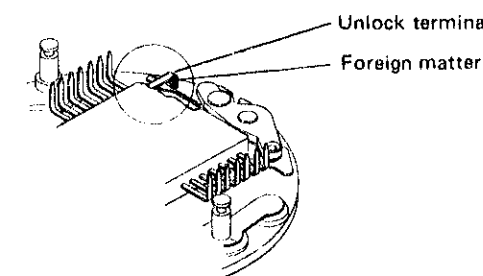

(2) Check to see if the setting button functions correctly.

- Check to see if the setting switch spring touches the pin of the circuit board as shown in the illustration. If it touches, correct it with tweezers.

Remarks:

- Make sure that there is no foreign matter (dust, lint) between the setting switch spring and the pin of the circuit board. Wipe off dust and lint if there is any.

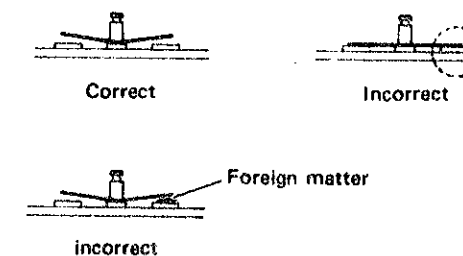

Check bulb condition

Check to see if there is a broken filament in the bulb.

(1) Set up the Volt-ohm-meter

Range to be used: OHMS R X 1

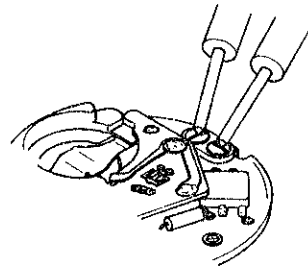

(2) Checking

Touch the tips of probes of the Volt-ohm-meter to the bulb holder screw.

Note: Touch the red and black probes to the screws respectively.

Light is lit Normal
Light is not lit Defective
Replace the bulb with new one.

All procedures of Disassembling and Reassembling, and Checking and Adjustment are completed.