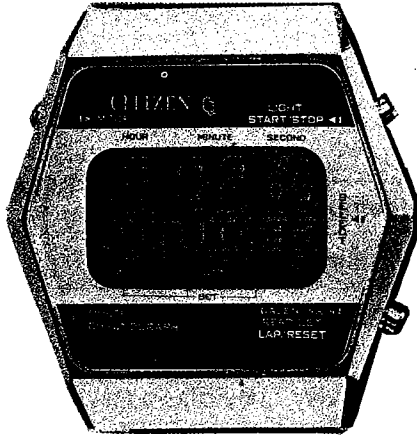

***TECHNICAL  
INFORMATION***

---

**CITIZEN QUARTZ  
Cal.No.922※※**

**§ 1. OUTLINE**

This is a digital quartz crystal watch with LC display, featuring multiple functions including the stopwatch, count-down and dual time displays in addition to the time and calendar displays.

In response to the requirements of the customer, the watch is characterized especially by the easiness in handling.

**§ 2. MAIN FEATURES**

- 1) In addition to the time and calendar displays, the multiple functions are incorporated such as the stopwatch (measurable down to 1/100 sec.), count-down and dual time displays.
- 2) The "mode mark" indicates distinctly the function of under the present use, and the segment of "day" runs in the case of timing under the stopwatch and the count-down functions.
- 3) An internal illumination lamp is built in to facilitate an easy readout of the display information even in a dark place.
- 4) The calendar is set automatically after being once set correctly, eliminating the trouble to set each time.
- 5) The power cell life indicating device indicates the time to replace the power cell through flashing of the colon on the screen.
- 6) One unit of the small-size silver oxide power cell ensures correct time keeping about 2 years.

## §3. SPECIFICATIONS

Caliber No.		9220A
Type		Digital-type quartz crystal watch with LC display
Movement		Diameter: 25.7 mm $\phi$
		Thickness: 5.0mm
Oscillation		32,678Hz
Accuracy		$\pm 10$ sec./month (in normal temperatures)
Display method		FE twist-type nematic LC display
Display information	Time	"Hour", "minute", "second", "date" and "day" (Constant display)
	Calendar	"Year", "month", "date" and "day" (By display switch)
	Stopwatch	"Hour", "minute", "second" and "1/100 sec." (By function switch)
	Count-down	"Hour", "minute" and "second" (By function display)
	Dual time	"Hour", "minute", "A/P" and "day" (By function switch)
Correction of display		Independent correction of each digit by operation of push-buttons
Effective temperature range		0°C ~ +60°C (32°F ~ 140°F)
Integrated circuit		C/MOS-LSI (1 unit)
Additional mechanisms		<ul style="list-style-type: none"> <li>●Stopwatch</li> <li>●Count-down</li> <li>●Dual time</li> <li>●Illumination lamp</li> <li>●Automatic calendar setting</li> <li>●Power cell life indicating device</li> <li>●Quick resetting device</li> </ul>
Power cell		Small-size silver oxide power cell (1 unit) Parts No. : 280-15 Voltage : 1.5V Capacity : 60mAH Size : 11.6mm $\phi$ × 3.0mm Life : About 2 years

§4. HANDLING INSTRUCTIONS

1) Push-buttons and switch of functions

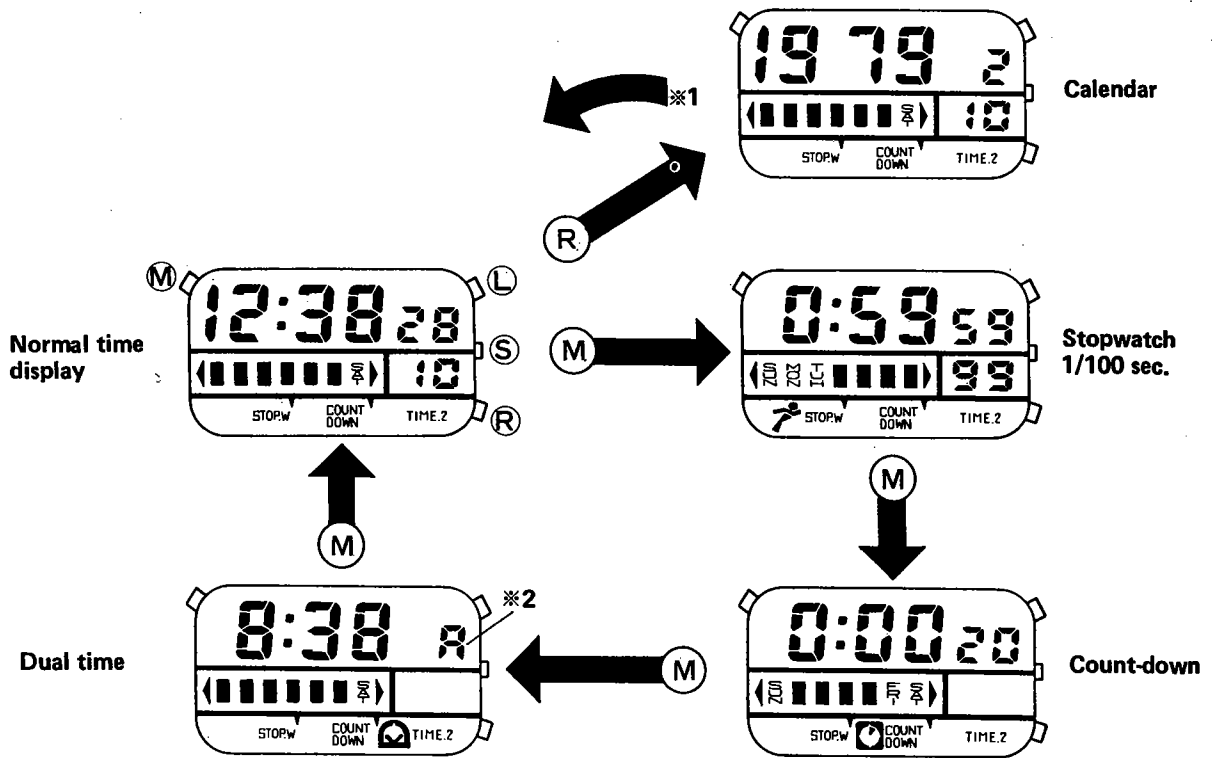
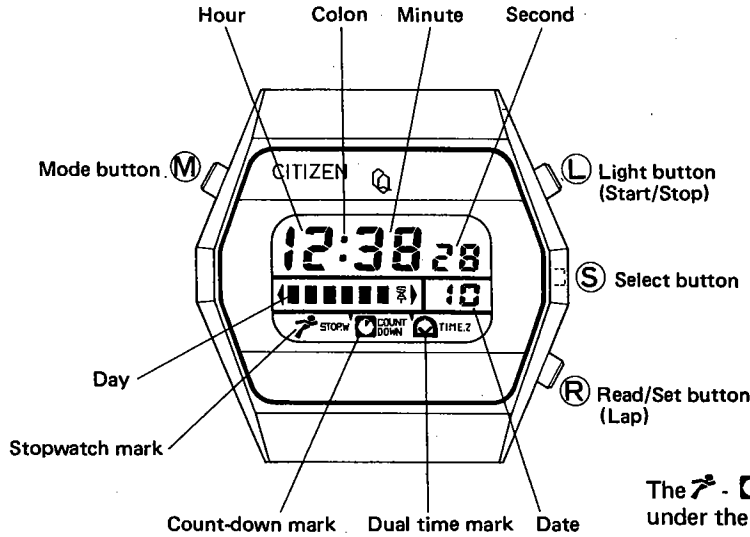

- ※1. The display switch between the time and the calendar is possible only while (R) button is pushed. With release of (R) button, the normal time display is recovered.
- ※2. The a.m. and p.m. are displayed in and at the place of the 1-second digit display. The and is displayed constantly under the dual time mode and only when the "hour" is set under the normal time display mode respectively.

2) Time and calendar setting

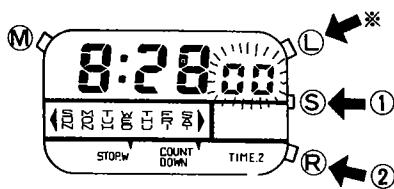

"Second" setting

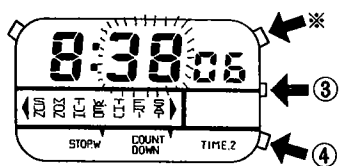

"Minute" setting

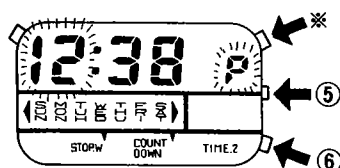

"Hour" setting

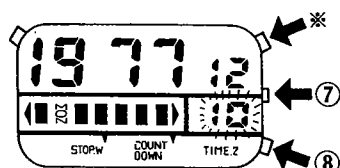

"Date" setting

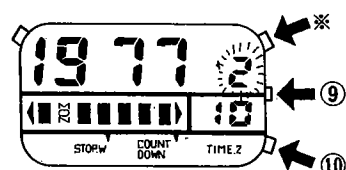

"Month" setting

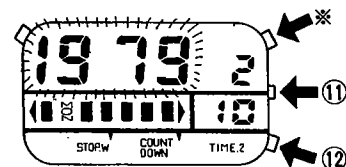

"Year" setting

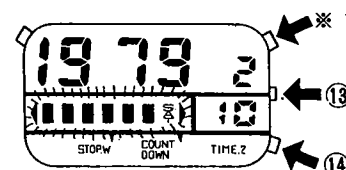

"Day" setting

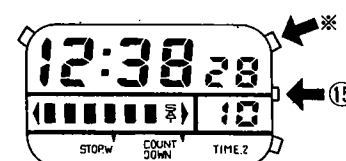

① With push of (S) button under the state of the normal time display, the "second" begins to flash to be set.

② With push of (R) button, the "second" is reset to "00" second to start then. (One "minute" is carried when the "second" is within the range of 30~59.)

③ With push of (S) button after "second" setting, the "minute" begins flashing to be set.

④ The "minute" is carried one by one with every push of (R) button, so correct "minute" can be set.

⑤ The "hour" and "A/P" begin to flash.

⑥ The "hour" and "A/P" are set. (Make sure A (a.m.) or P (p.m.) when setting "hour".)

⑦ The "date" begins to flash.

⑧ The "date" is set.

⑨ The "month" begins flashing.

⑩ The "month" is set.

⑪ The "year" begins to flash.

⑫ The "year" is set. (The year can be set up to 1999.)

⑬ The "day" begins to flash.

⑭ The "day" is set.

⑮ The normal time display is recovered.

\*With push of (L) button, the normal time display can be secured from any display mode (Quick resetting device).

3) Operation of stopwatch function

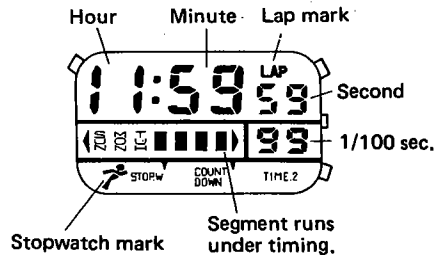

\*The illumination lamp does not light up under the operation of the stopwatch function even though (L) button is pushed.

\*The segment of the "day" runs from left to right under timing (stopwatch/lap).

(1) Resetting method (available in ① ~ ⑤)

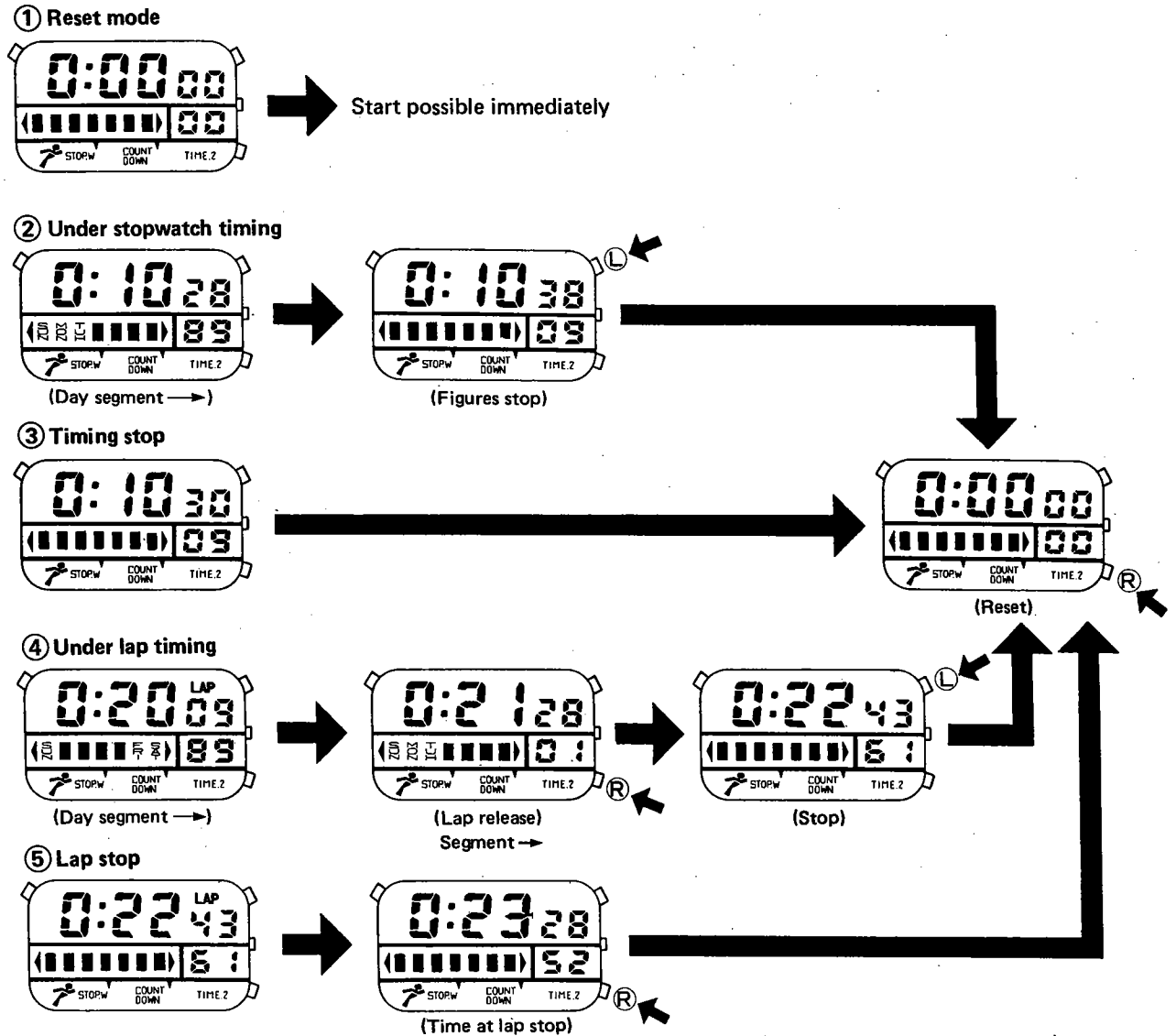

(2) Timing method

① Simple timing

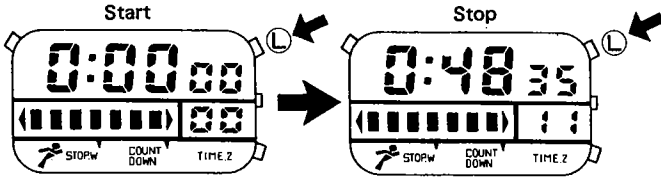

② Integrating timing

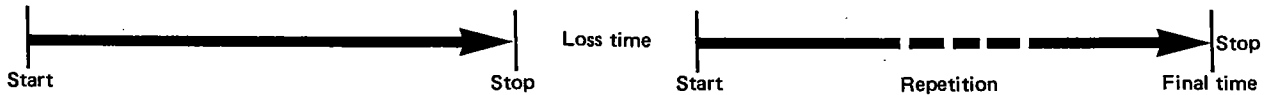
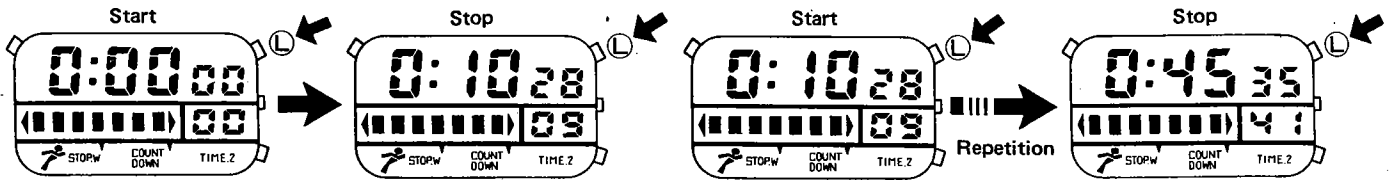

③ Lap time

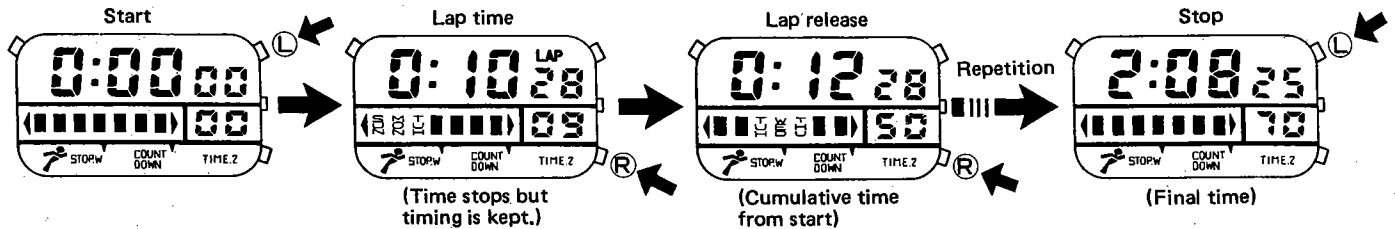

④ Simultaneous timing of 1st and 2nd places

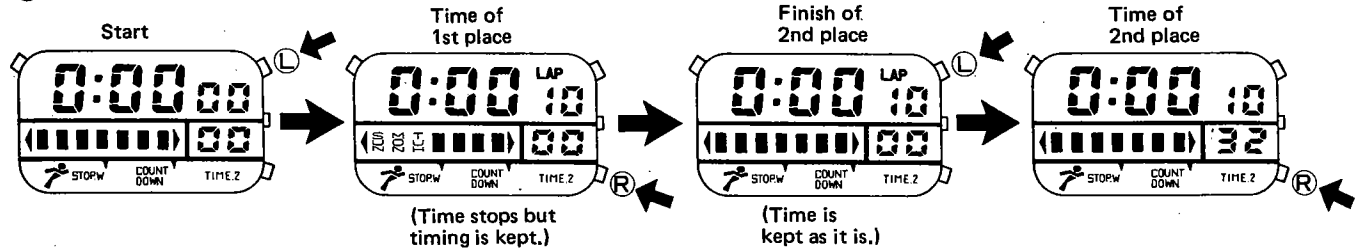

The timing is continued yet even if the display is switched to another mode under the stopwatch timing.

#### 4) Operation of count-down function

##### (1) Setting of time

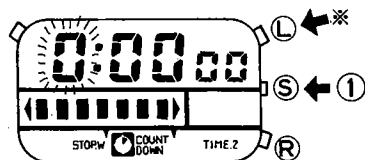

"Hour" setting

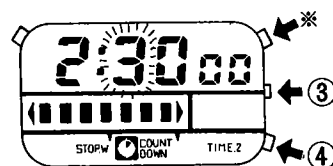
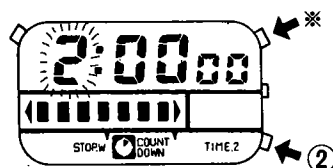

"10-min. digit" setting

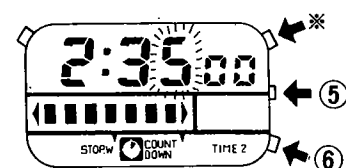

"1-min. digit" setting

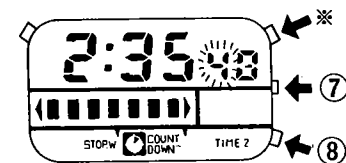

"10-sec. digit" setting

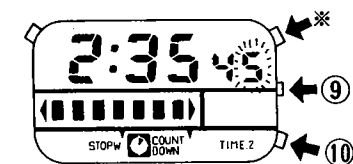

"1-sec. digit" setting

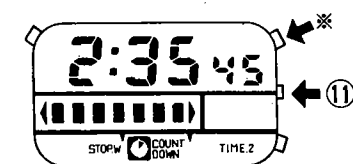

\*The illumination lamp does not light up under the operation of the count-down function even if L button is pushed.

① With push of S button after switching to the count-down display (either of the under-timing and stop states), the display is stopped and reset. Then "hour" begins to flash.

② One "hour" is carried with every push of R button.

③ Only the 10-digit of the "minute" begins to flash.

④ The 10-digit of the "minute" is set.

⑤ Only the 1-digit of the "minute" begins to flash.

⑥ The 1-digit of the "minute" is set.

⑦ Only the 10-digit of the "second" begins to flash.

⑧ The 10-digit of the "second" is set.

⑨ Only the 1-digit of the "second" begins to flash.

⑩ The 1-digit of the "second" is set.

⑪ The time setting mode is secured. (The time setting is over.)

\*With push of L button, the time setting mode can be secured from any setting mode.



**(2) Start/stop**

After the time setting, the timing is started with push of (L) button. The segment of the "day" runs from right to left simultaneously with the start of the timing. The timing can be stopped with push of (L) button.

\*When the time shows " 0:00:00 " after the start of the count-down, the integration is started immediately as an up-counter.

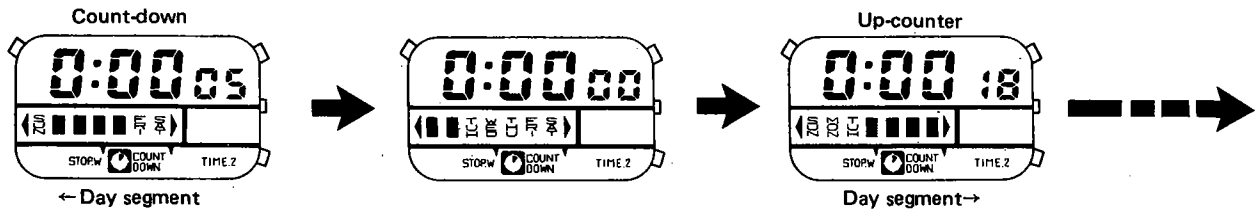

In this case, the running direction of the day segment changes from right-to-left to left-to right.

Timing is continued yet even if the display is switched to another mode under the count-down timing.

**5) Operation of dual time function**

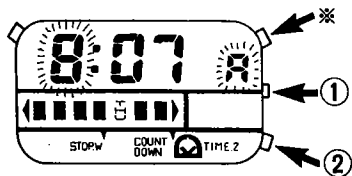

"Hour" setting

① With push of (S) button under the normal dual time display, the "hour" and "A/P" begin to flash.

② The "hour" and "A/P" are set.

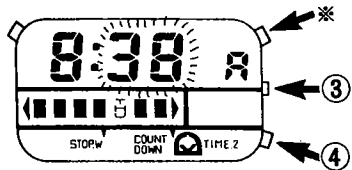

"Minute" setting

③ The "minute" begins to flash.

④ The "minute" is set.

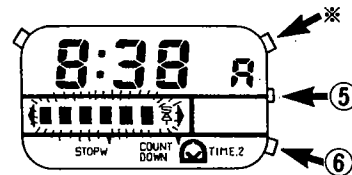

"Day" setting

⑤ The "Day" begins to flash.

⑥ The "Day" is set.

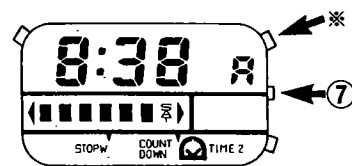

⑦ The normal dual time display is secured.

\*The normal dual time display can be secured with push of (L) button from any display mode.

§ 5. DISASSEMBLY AND ASSEMBLY OF MOVEMENT

Disassembling sequence: ① ~ ⑬

Assembling sequence: ⑬ ~ ①

The number of the screw coming with the parts is shown by the symbol like ( T 1).

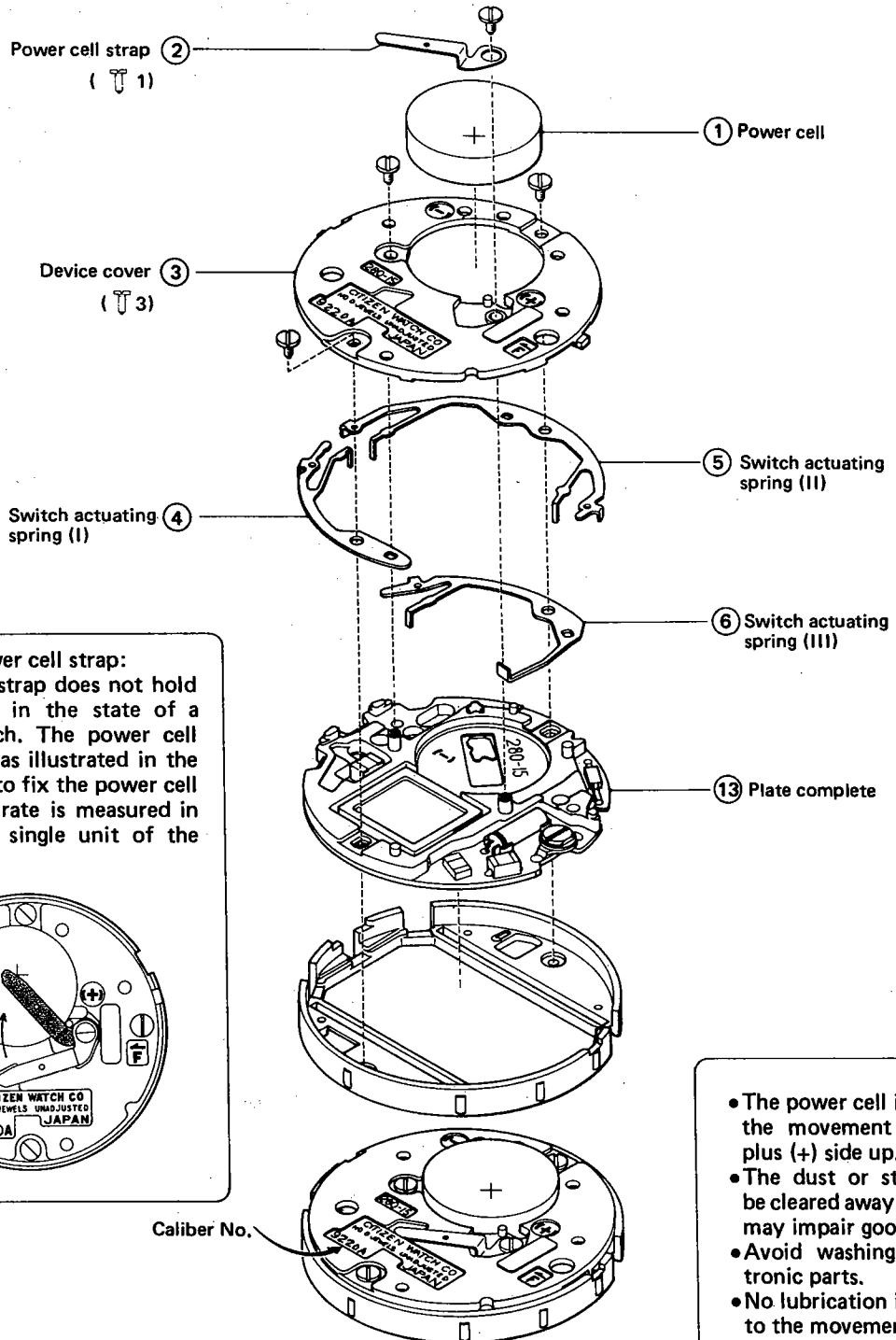

**Handling of power cell strap:**  
 The power cell strap does not hold the power cell in the state of a completed watch. The power cell strap is turned as illustrated in the diagram below to fix the power cell when the time rate is measured in the state of a single unit of the movement.

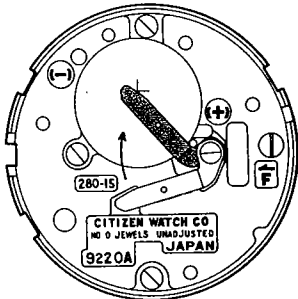

- The power cell is put into the movement with the plus (+) side up.
- The dust or stains must be cleared away since they may impair good contact.
- Avoid washing the electronic parts.
- No lubrication is required to the movement.

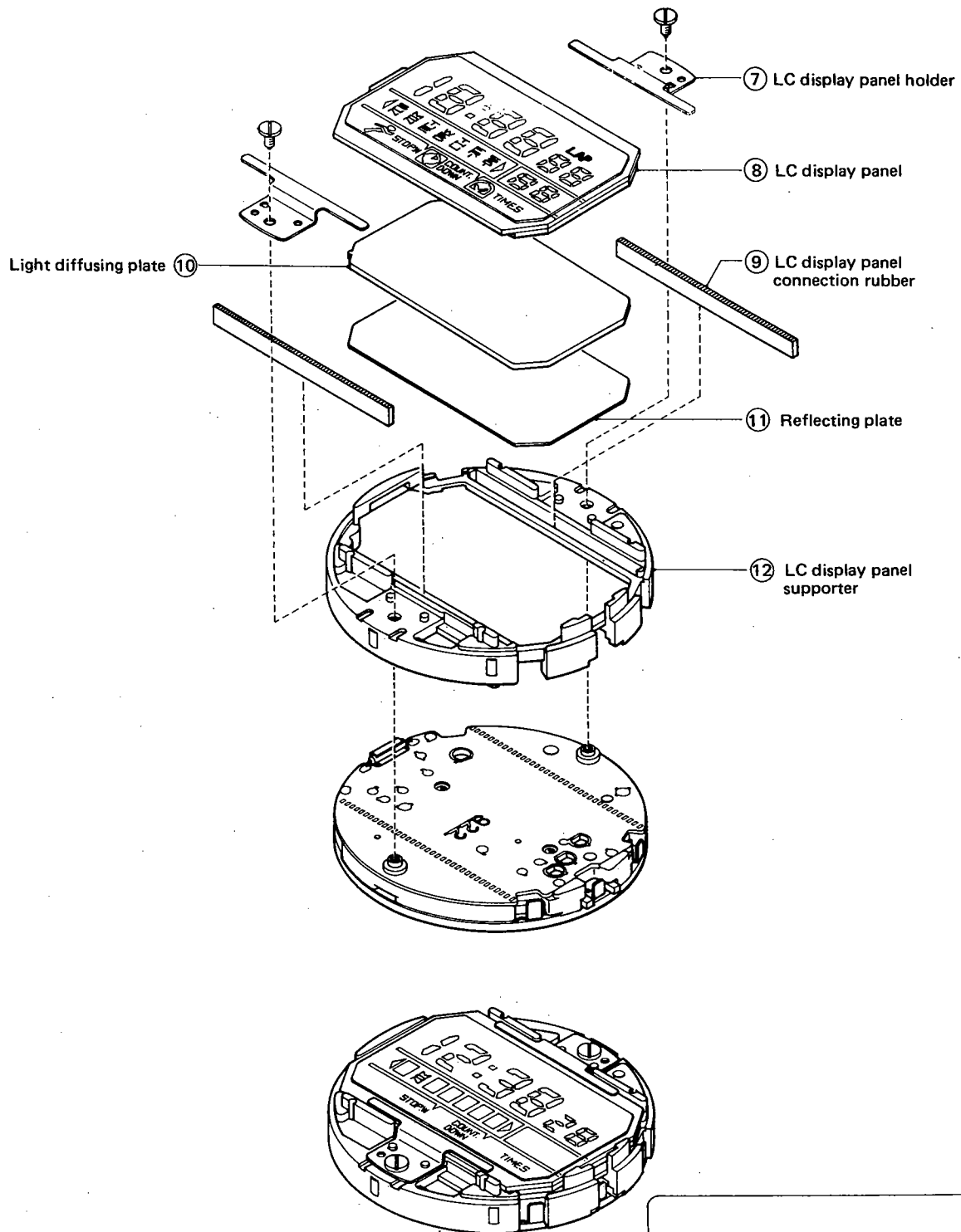

The LC display panel and the plate complete must be handled by holding softly the utmost circumferences of them in order to avoid giving flaws or stains.

§ 6. TROUBLESHOOTING AND ADJUSTMENT

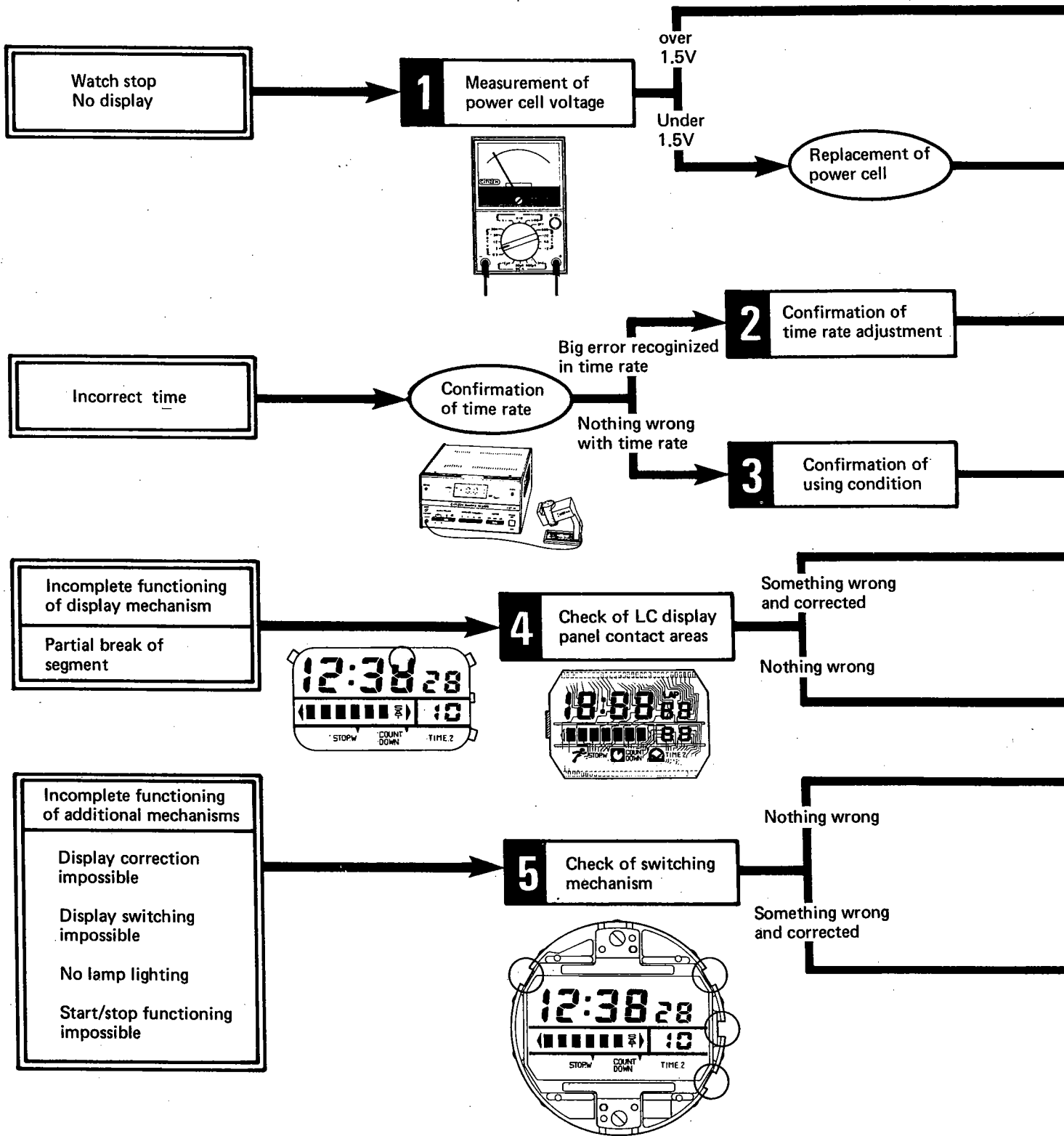

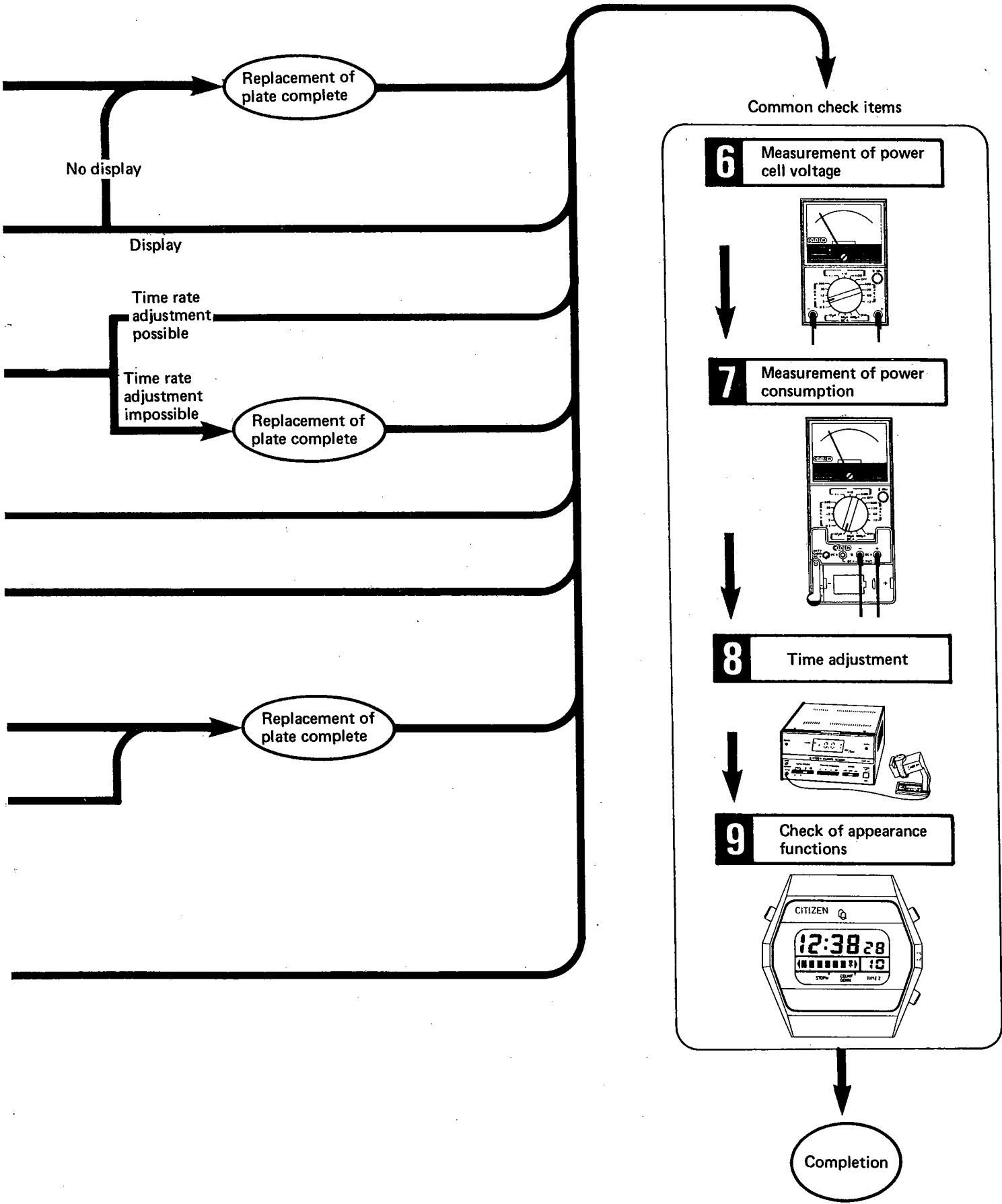

Replacement of plate complete

No display

Display

Time rate adjustment possible

Time rate adjustment impossible

Replacement of plate complete

Replacement of plate complete

Common check items

6 Measurement of power cell voltage

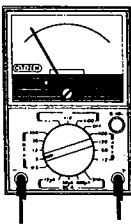

7 Measurement of power consumption

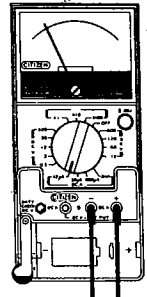

8 Time adjustment

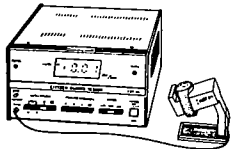

9 Check of appearance functions

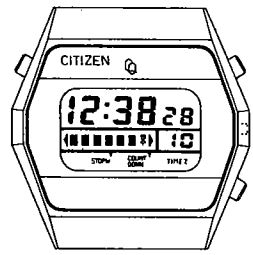

Completion

Watch stop – No display

1 Measurement of power cell voltage

Power cell voltage: Over 1.5V

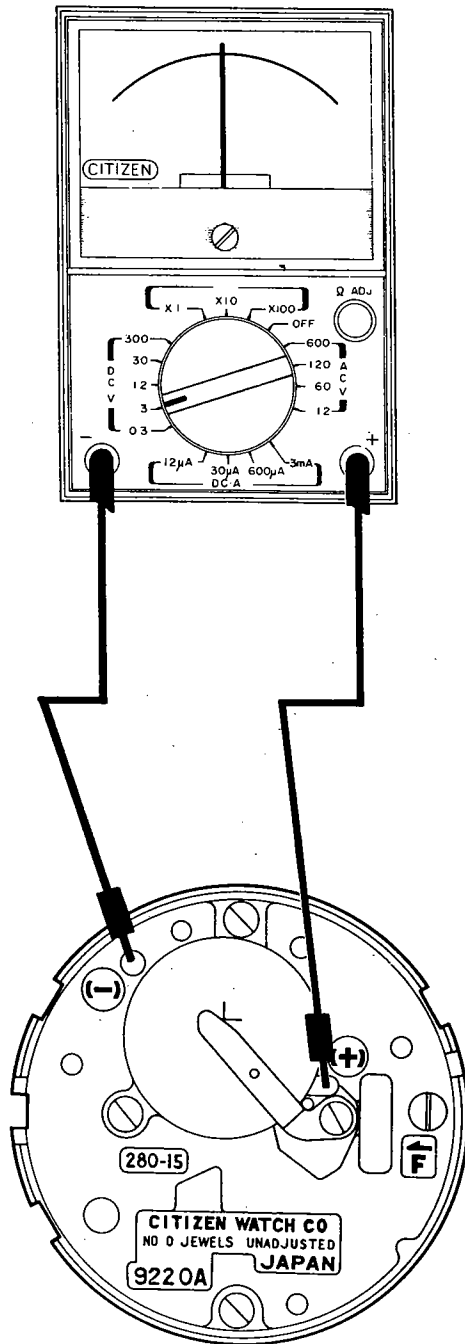

Results and Treatment

Over 1.5V

- No display of LC display panel  
→ Replacement of plate complete

Under 1.5V

After replacement of power cell:

- Display of LC display panel  
→ 7 Measurement of power consumption
- No display of LC display panel  
→ Replacement of plate complete

Note

In case the watch has been used more than 2 years, the power cell must be replaced with new one although it shows more than 1.5V output.

How to Install Power Cell

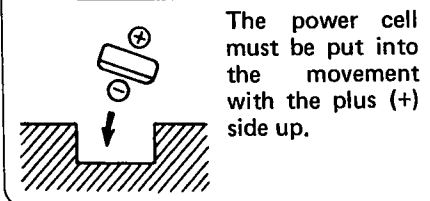

The power cell must be put into the movement with the plus (+) side up.

\*In case the measured value is unsteady when the power cell is incorporated into the movement although the power cell itself shows more than 1.5V output, a poor contact is conceivable for the power cell. So a meticulous care must be given to the malformation of the contact surface as well as to the dust and stains stuck there.

**Big error recognized in time rate**

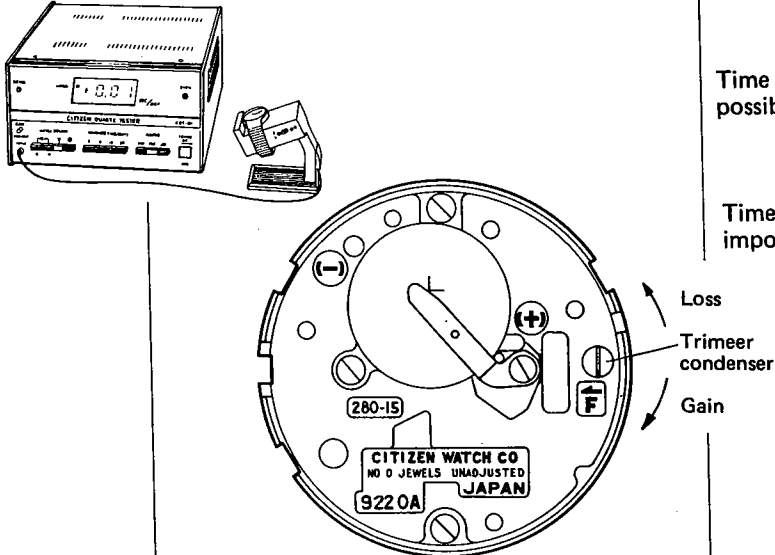
Check items	How to check	Results	Treatment
<p><b>2</b> Confirmation of time rate</p>  <p>In case a big error is recognized in the time rate, the trimmer condenser is turned to adjust the time.</p> <p>In case the time adjustment is impossible even with turning the trimmer condenser, the quartz crystal oscillator may have some fault. And the trimmer condenser may have some trouble if the time rate has no change at all.</p>	<p>In case a big error is recognized in the time rate, the trimmer condenser is turned to adjust the time.</p> <p>In case the time adjustment is impossible even with turning the trimmer condenser, the quartz crystal oscillator may have some fault. And the trimmer condenser may have some trouble if the time rate has no change at all.</p>	<p>Time adjustment possible → Common check items</p> <p>Time adjustment impossible → Replacement of plate complete</p>	<p>Common check items</p> <p>Replacement of plate complete</p>

**Nothing wrong with time rate**

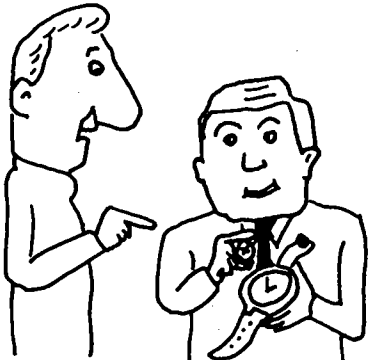
Check items	How to check	Results	Treatment
<p><b>3</b> Confirmation of using condition</p>	<p>How the watch has been used must be confirmed to the customer.</p> <ol style="list-style-type: none"> <li>1. Check whether the customer made some mistake in handling the watch.</li> <li>2. Check whether the watch was used in the extreme temperatures, i.e., outside the effective temperature range.</li> <li>3. Check how many days have passed since the watch had the time adjustment last.</li> <li>4. And other using factors.</li> </ol> 		

Incomplete functioning of display mechanism – Partial break of segment

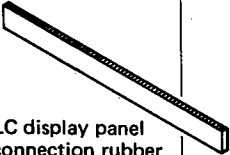
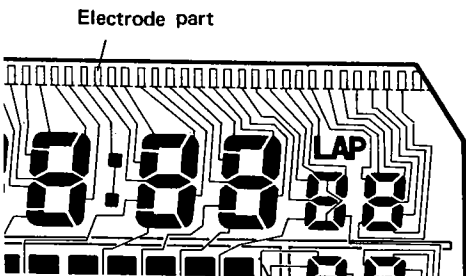
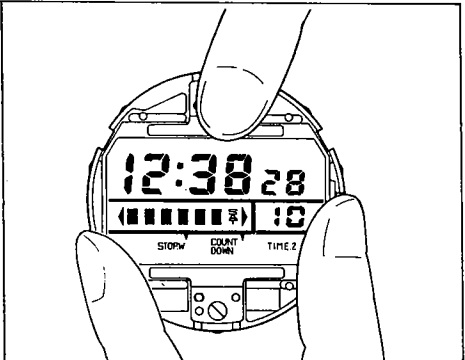
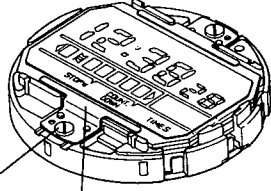
Check items	How to check	Results	Treatment
<p><b>4</b> Check of LC display panel contact areas</p>  <p>LC display panel connection rubber</p>	<p>For the facors of the partial break of the segment, a poor contact is first considered between the LC display panel and the electronic circuit. Secondly, some fault is conceivable within the electronic circuit. In this connection, the following inspections are given.</p> <ol style="list-style-type: none"> <li>1. Check of screw for LC display panel holder                     <ol style="list-style-type: none"> <li>(1) Check whether the screw for the LC display panel holder is loosened or not.</li> <li>(2) Check whether the LC display panel holder is holding the LC display panel evenly with no upward warp.</li> </ol> </li> <li>2. Check of LC display panel connection rubber                     <ol style="list-style-type: none"> <li>(1) Is the rubber twisted?</li> <li>(2) Is the rubber worn out or stretched extremely?</li> <li>(3) Are there any dust or stains stuck to the rubber?</li> </ol> </li> <li>3. A meticulous care must be given to the dust or stains at the LC display panel contact areas as well as to the crack of the electrode part which has some partial break of the segment.</li> </ol>  <p>Electrode part</p> <p><b>Note:</b> Never fail to clear away completely the dust stuck to the electrode part because it may result in a large amount of the power consumption.</p> <p><b>Check point:</b> As shown in the diagram below, the place near the broken segment area is pressed softly with a finger. And if the broken segment is displayed again, it is manifest that the contact is unsteady.</p> 	 <p>Screw for LC display panel holder</p> <p>LC display panel holder</p> <p>Screw borken → Replacement</p> <p>Screw loosened → Retightening</p> <p>Panel held unevenly → Reassembly</p> <p>Deformation of display holder → Replacement</p> <p>Rubber twisted or worn out → Replacement</p> <p>Dust or stains sticked → Clearing</p> <p>Dust or stains sticked → Clearing</p> <p>Electrode cracked → Replacement</p> <p>Nothing wrong with above checks → Replacement of LC display panel</p> <p>Non-correctable yet → Replacement of plate complete</p>	<p><b>Note:</b> Take good care not to apply strong force to press the LC display panel in order to avoid cracking of the glass.</p>

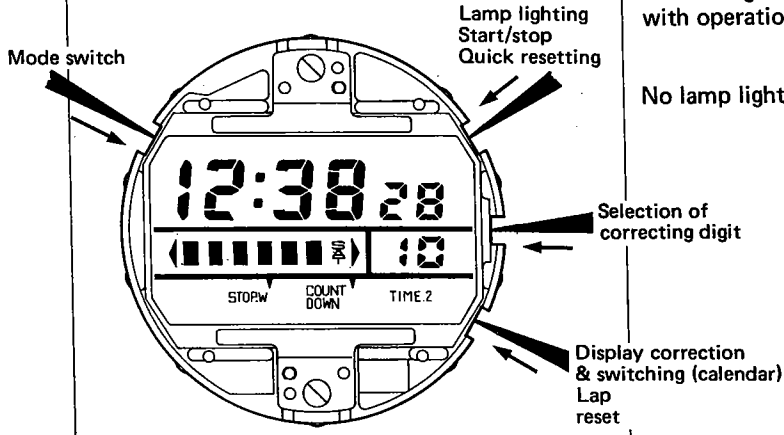
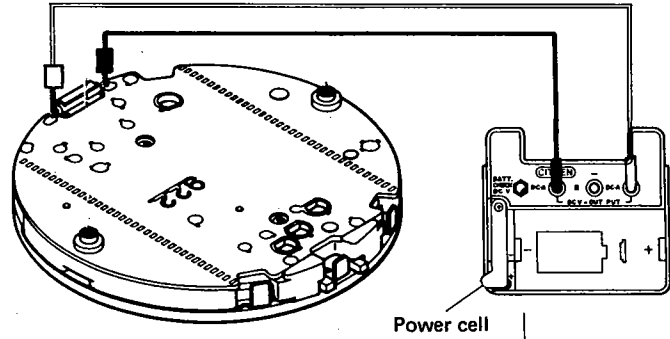

**Incomplete functioning of additional mechanisms — Display switch and correction impossible; No lamp lighting and others**

Check items	How to check	Results	Treatment
<p><b>5</b> Check of switching mechanism</p>	<p>The movement is taken out of the watchcase.</p> <p>1. As shown in the diagram below, each switch actuating spring corresponding to each push-button is pressed with a tweezers or the like to check the correct operation for each spring.</p>  <p>*The lamp does not light up under the count-down or the stopwatch display.</p> <p>2. Check of lamp lighting mechanism As shown in the diagram below, the adaptors of the Citizen Multi-Tester are applied to the both terminals of the lamp attached to the plate complete in order to check whether the lamp lights up or not.</p> 	<p>Nothing wrong with operation (No trouble in movement) → 3. Check of push-buttons</p> <p>Something wrong with operation → 4. Check of switch actuating springs</p> <p>No lamp lighting → 2. Check of lamp lighting mechanism</p> <p>Lamp lighting → 4. Check of switch actuating springs</p> <p>No lamp lighting → Replacement of plate complete</p>	

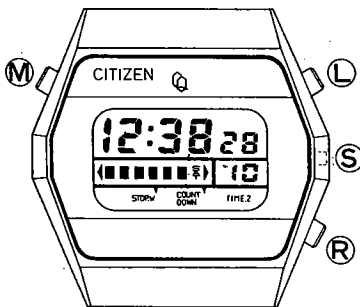
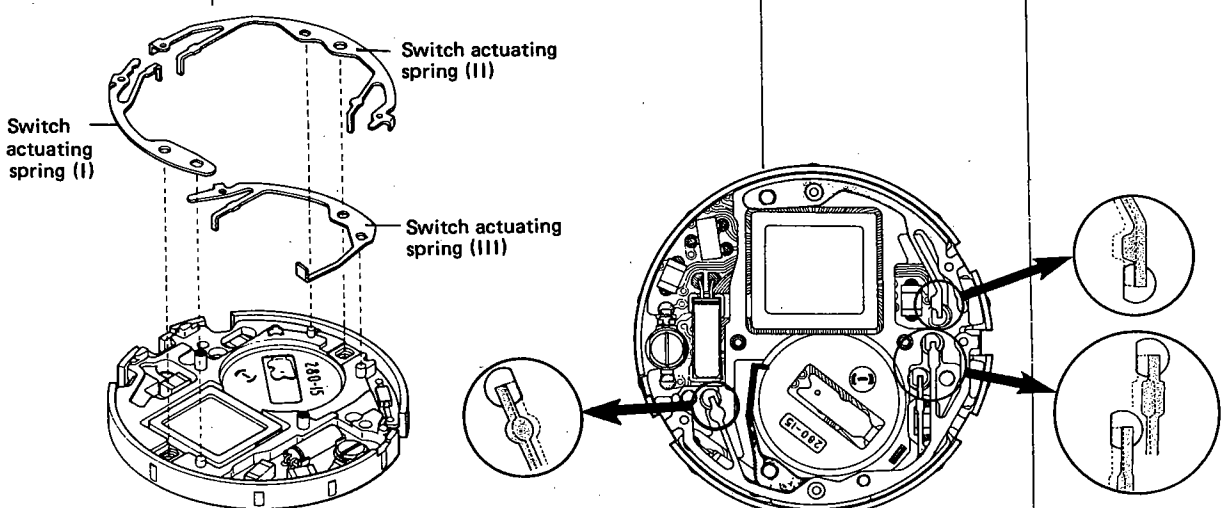
Check items	How to check	Results	Treatment
	<p>3. Check of push-buttons In case nothing wrong is recognized with the movement, the push-buttons may have some fault. Each push-button is taken out of the watchcase.</p> <p>(1) Check whether each push-button has some bend or not.</p> <p>(2) Check whether any dust or stains stick to the push-button as well as to the areas of the case where the push-buttons are to be attached.</p> <p>(3) Set each push-button to the watchcase and check whether each button has a smooth operation.</p>  <p>*The silicon oil must be applied to the packing of each push-button.</p> <p>4. Check of switch actuating springs</p> <p>(1) Check whether each switch actuating spring is deformed or broken.</p> <p>(2) Check whether the contact part of each switch actuating spring has a correct contact to the pattern of the plate complete.</p> <p>*An inspection must be given to the dust and stains stuck to the contact part as well.</p> 	<p>Push-button deformed or broken</p> <p>Dust or stains stuck</p> <p>Spring deformed or broken</p> <p>Nothing wrong with above checks</p>	<p>Replacement</p> <p>Clearing</p> <p>Replacement and reassembly</p> <p>Replacement of plate complete</p>

## Common check items

## 6 Measurement of power cell voltage

Power cell voltage: Over 1.5V

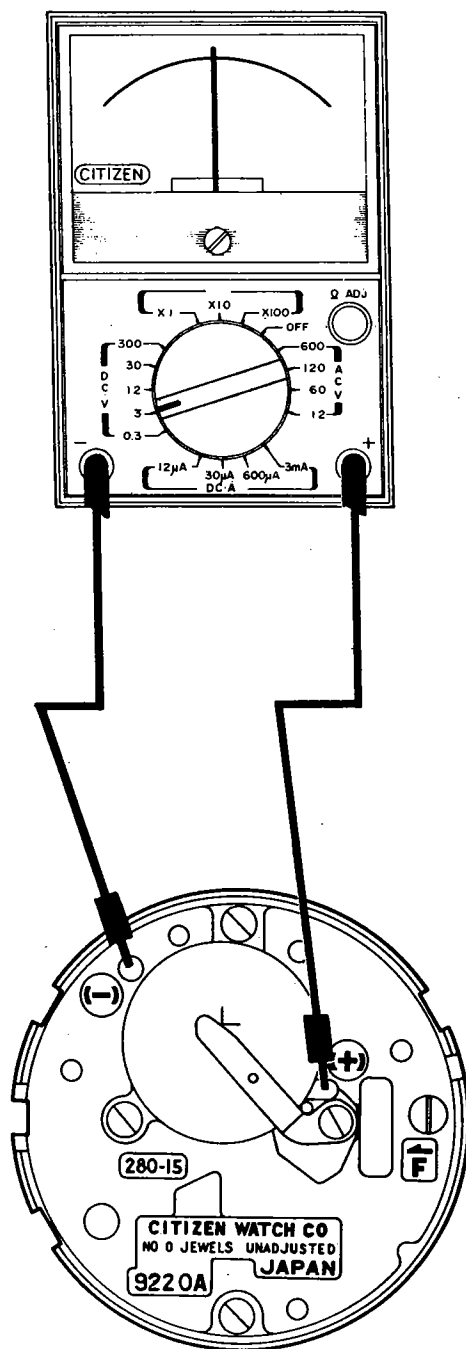

## Results and Treatment

Over 1.5V

→ 7 Measurement of power consumption

Under 1.5V

After replacement of power cell:

→ 7 Measurement of power consumption

## Note

In case the watch has been used more than 2 years, the power cell must be replaced with new one although it shows more than 1.5V output.

7 Measurement of power consumption

Power consumption: Under  $4.0\mu A$

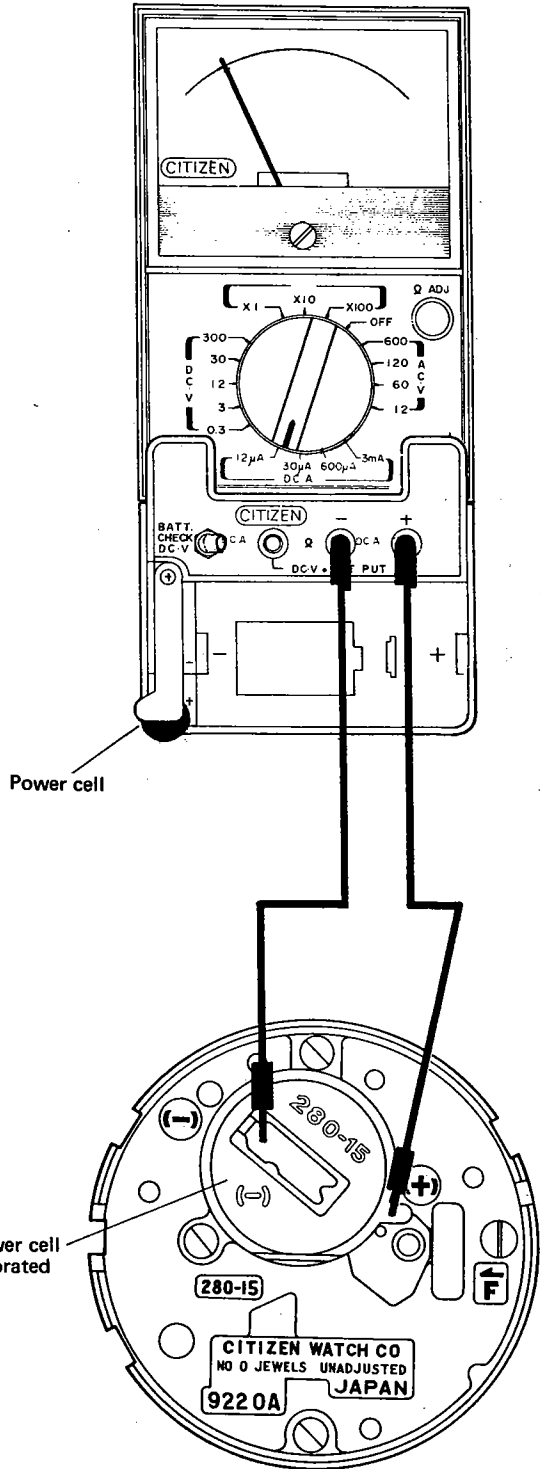

Results and Treatment

1. Measurement under normal time display

**Under  $4.0\mu A$**

→ 8 Time adjustment

**Over  $4.0\mu A$**

→ 2. Measurement of power consumption at electronic circuit part

2. Measurement of power consumption at electronic part with LC display panel removed

**Under  $2\mu A$**

→ Replacement of LC display panel connection rubber or LC display panel (Also check dust and stains at electrode part carefully.)

**Over  $2\mu A$**

→ Replacement of plate complete

Note

The power cell to be put into the power cell holder of the adaptor must show more than 1.5V output.

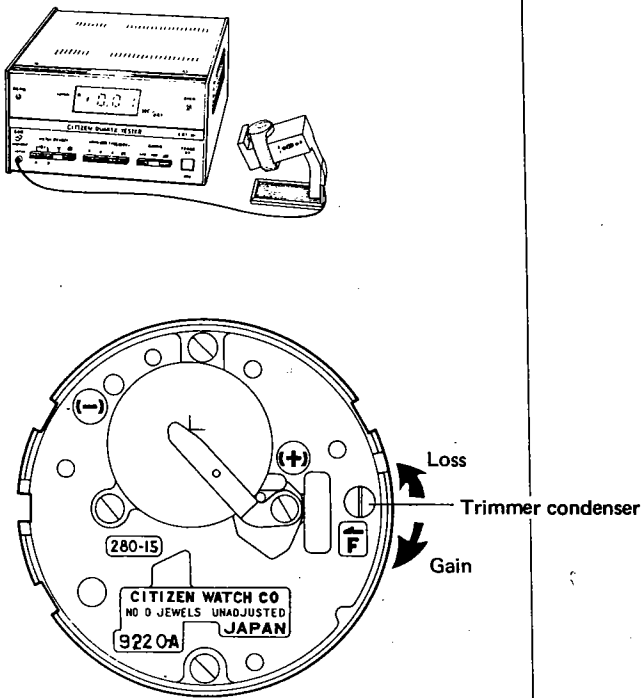
Check items	How to check	Results	Treatment
<b>8</b> Time adjustment	<p>The time rate is measured using a timing machine, and the time is adjusted by turning the screw of the trimmer condenser.</p>  <p>The diagram illustrates the timing process. At the top, a 'CITIZEN PULSE METER' is shown with a digital display of '0.00'. Below it, a watch movement is shown with the trimmer condenser screw. Arrows indicate that turning the screw clockwise leads to 'Loss' and counter-clockwise leads to 'Gain'. The movement is labeled with '280-15', 'CITIZEN WATCH CO', 'NO 0 JEWELS UNADJUSTED', and '922 0A JAPAN'.</p>		

Check items	How to check	Results	Treatment
<b>9</b> Check of appearance functions	<p>Finally, the following points are confirmed.</p> <ol style="list-style-type: none"> <li>1. The figures displayed have nothing wrong.</li> <li>2. Each function can be operated through each push-button in a smooth and correct way.</li> <li>3. No dust nor stains stick to the appearance parts at all.</li> </ol>  <p>The diagram shows a Citizen digital watch with a rectangular case. The display shows '12:38 28' and a bar graph. Below the display are three buttons labeled 'STOPW', 'COUNT DOWN', and 'TIME 2'. The watch face also features the 'CITIZEN' logo and a small icon.</p>		

**CITIZEN WATCH CO., LTD.**  
Tokyo, Japan